

X *GYRO REMOTE CONTROL SERIES* **5HW 2.4G**

4-CHANNEL PRESSURE HOVERING HEIGHT-ADJUSTMENT REMOTE CONTROL 6-AXIS FLYCOPTER

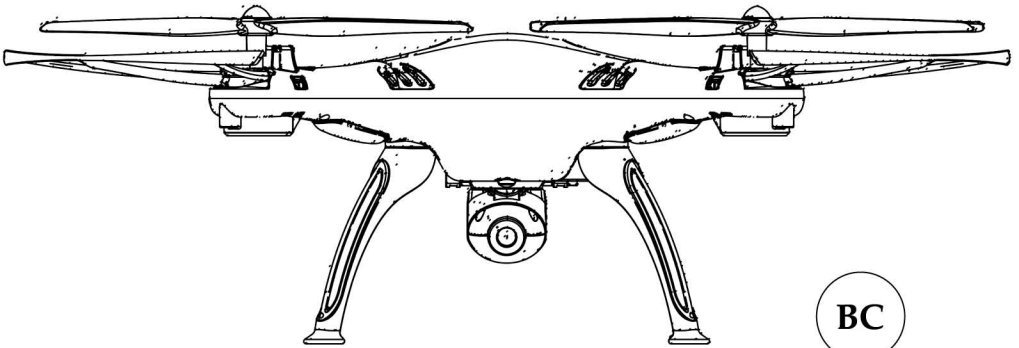

4

USER MANUAL

OPERATING STANDARDS: GB/T26701-2011

MAIN FEATURES

- Utilises the 4-axis structure, enabling the aircraft to be even more flexible, speedy, and possessing a relatively stronger wind-withstanding capability. Also it can conduct flights in interior as well as exterior environment.
- A 6-axis gyro direction stabiliser is built-in, ensuring precise positioning in the air.
- The structure uses modular designs, making installation simple and repair and maintenance easier.
- Capable of 360° 3D overturning function and fling-flying function.
- Headless function is enabling the aircraft to be summoned back with ease.
- Brand new pressure hovering height-adjustment function.

The content, specifications or accessory packaging of internal products in this user manual is strictly for reference only. Our company will not be responsible for errors in the printed contents and it will not be able to proactively notify the consumers. For any updates or errors, please abide by the SYMA MODEL AIRCRAFT's website as accurate.

Safety guide

1. Please store the smaller-sized aircraft accessories in places that are out of reach of children, in order to avoid the occurrence of accidents.
2. This aircraft is very powerful. For all first-time flight, it shall be observed that the left gear shift joystick must be slowly pushed in order to prevent the aircraft from ascending too quickly and result in unnecessary collision and damages.
3. When the flight is ended, the power supply of the remote control shall be switched off firstly, and then, followed by the switching off of the power supply of the aircraft.
4. Avoid placing the batteries in places with high temperatures and exposure to heat (for example, naked light or electrical equipment installations).
5. Take extra precaution to ensure that the aircraft is at a distance of 2 to 3 metres from the user or other people in order to prevent the aircraft from colliding into the head, face or body, etc. of other people during landing.
6. When young children are operating the aircraft, it shall be ensured that the adults are guiding and making sure that the aircraft control is within the viewing range of the controller (or instructor) such that it makes the control very convenient.
7. Non-rechargeable batteries are prohibited for recharging. When installing or changing the batteries, please take extra care on the polarities of the batteries; mixing new and old batteries or different types of batteries are strictly disallowed.
8. When the aircraft is not in use, please switch off the power supplies of both the aircraft and the remote control, and remove the batteries in the remote control.
9. The terminals & power supply cannot be short-circuited.
10. Product operating temperature of 35°.

Repair and maintenance

1. Always use dry and soft cloth to clean this product.
2. Avoid this product to be exposed to sunlight or heat.
3. Avoid immersing these toys into water, otherwise ,the electronic parts may be damaged.
4. Regularly Check and inspect the plug and other accessories. If any damages are discovered, please immediately stop using it, until it is completely repaired in good working condition.

Package description

The following items can be found in this product package:

- Aircraft
- Remote Control
- Main Blade
- Instruction Manual
- Screwdriver
- Protection Gear
- WiFi Camera
- Mobile Phone Retaining Clip
- Screws (4 nos.)
- Foot Stand
- USB Cable



Understanding your remote control

Remote control's button function description:

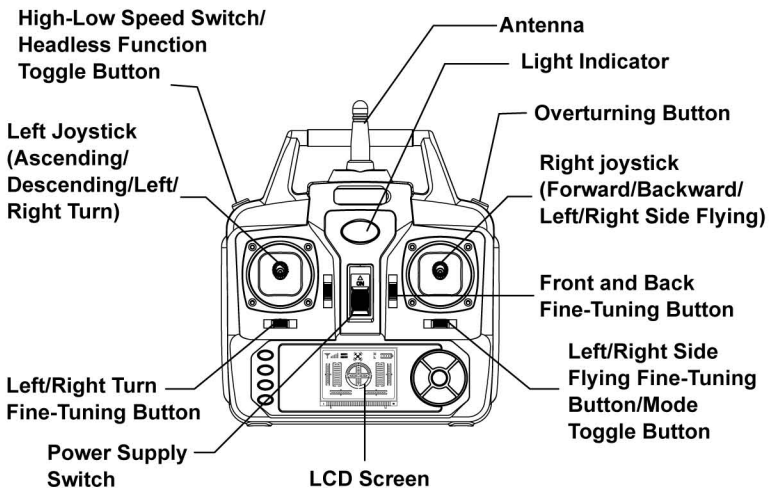

Battery installation for remote control:

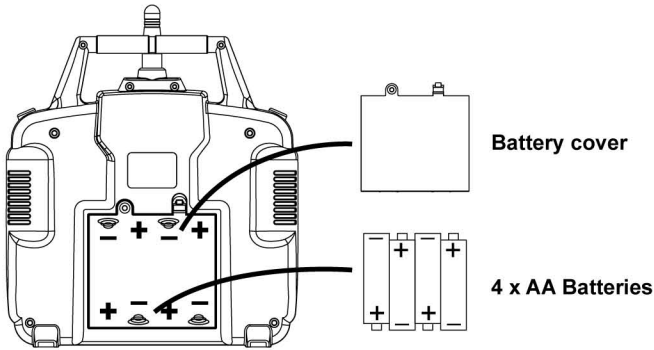

1. **Battery Installation Method:** Open up the battery cover at the back of the remote control. Correctly place 4 x AA alkaline batteries in the battery box in strict adherence to the polarity instructions (the batteries are optional).



1. During the battery installation, it must be ensured that the polarities of the batteries are matched with that of the battery box. No battery shall be installed with the opposite polarity.
2. Please do not use new and old batteries together.
3. Please do not use different types of batteries together.

Remote control button and lcd display functions description

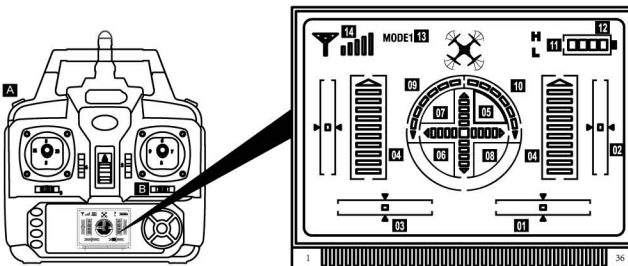

1. **Fine-tuning of left and right side flying:** After switching on the remote control, it is displayed at the middle point.
2. **Fine-tuning of forward and back:** After switching on the remote control, it is displayed at the middle point.
3. **Fine-tuning of left and right turning:** After switching on the remote control, it is displayed at the middle point.
4. **Accelerator Display:** After frequency-matching, it is displayed at the middle point.
5. **Forward Display:** When the right joystick is pushed forward, it will be gradually ascended; the forward speed of the aircraft will be gradually increased.
6. **Backward Display:** When the right joystick is pushed backward, it will be gradually ascended; the backward speed of the aircraft will be gradually increased.
7. **Left Side Flying Display:** When the right joystick is pushed to the left, it will be gradually ascended; the left side flying speed of the aircraft will be gradually increased.
8. **Right Side Flying Display:** When the right joystick is pushed to the right, it will be gradually ascended; the right side flying speed of the aircraft will be gradually increased.
9. **Left Turning Display:** When the left joystick is pushed to the left, it will be gradually ascended; the left turning speed of the aircraft will be gradually increased.
10. **Right Turning Display:** When the left joystick is pushed to the right, it will be gradually ascended; the right turning speed of the aircraft will be gradually increased.
11. **Fast-Slow Gear Display:** Press against Button A can enable the aircraft to execute the toggle of fast-slow gear. The fast gear is H, while the slow gear is L.
12. **Power Supply Display:** Display the current power capacity of the remote control.
13. **Mode Display:** The default is MODE1 upon starting up. Push the Button B to the right and switch on the power supply switch at the same time can toggle to MODE2.
14. **Signal Display:** Display the strong and weak signals.

Installation procedures for foot stand and protective ring of the aircraft

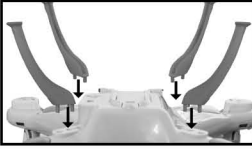

Figure (1)

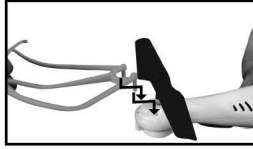

Figure (2)

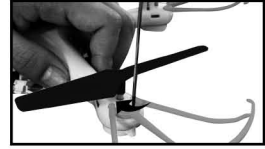

Figure (3)

1. Install the foot stand into the main body as shown in Figure (1).
2. Install the protective gear into the main body as shown in Figure (2).
3. Tighten the screws in a clockwise direction as shown in Figure (3).

Wifi real-time transmission aerial photo-taking component installation

Mobile phone retaining clip installation:

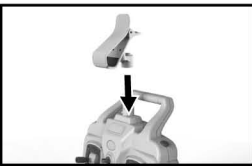

Figure (1)



Figure (2)

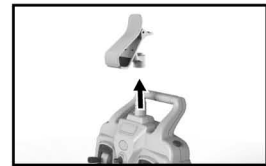

Figure (3)

1. Align the mobile phone retaining clip with the antenna of the remote control and insert it in.
2. Use strength to press against the spring section of the retaining clip to adjust the size.
3. Hold tight to the mobile phone retaining clip and pull upwards with sufficient force to remove the mobile phone retaining clip.

Wifi real-time transmission aerial photo-taking component installation

1. Download the installation software:

For Android mobile phones, please kindly (visit www.symatoys.net) or scan the QR code to download the SYMA FPV installation software.

For Apple mobile phones, please kindly proceed to APP STORE to download the SYMA FPV installation software or scan the QR code to download the SYMA FPV installation software.

Warm reminded: Two-dimension code is provided in color box packing and back cover of specification to scan. Please concern official website APP STORE of SYMA or the latest reminder of Google play to acquire the latest SYMA FPV.

2. Connection description:

Connect model power supply. The FPV light indicator is green and will become red blinking light after approximately 20 seconds, awaiting the connection for mobile phone. At this moment, click on "Settings" option in mobile phone and activate WIFI. In the WIFI's search column, look for "FPV WIFI ****" connection, and click on connection until the message "has been connected" is shown, which indicates that the connection is successful. Now, exit the "Settings" option. Open up the SYMA FPV software, and click the "START" icon to enter into the control panel. The mobile phone screen has entered into the real-time imaging scenarios. The full bar of the WIFI's signal indicates that the current signal is at its strongest.



1. Open up SYMA FPV software.

2. Click on "START" icon.

3. The mobile phone screen displays with real-time imaging scenarios.

3. Real-time transmission gui icon description



1. Back
2. WIFI's Signal
3. Checking of Photos and Videos
4. Video Recording
5. Photo-Taking
6. Video Recording Time Display

4. Real-time transmission aerial photo-taking

Photo-Taking and Video Recording: When the WIFI camera is operating in normal conditions, please click on the photo or video icon on the real-time transmission GUI, and immediately you can conduct photo-taking or video recording. (The completed files for photo-taking or video recording can be found in the “Checking of Photos and Videos” files.)

Note: When activating the mobile phone software to conduct real-time transmission operating mode, the flight distance of the aircraft will be shortened by half!

Aircraft operation guidance

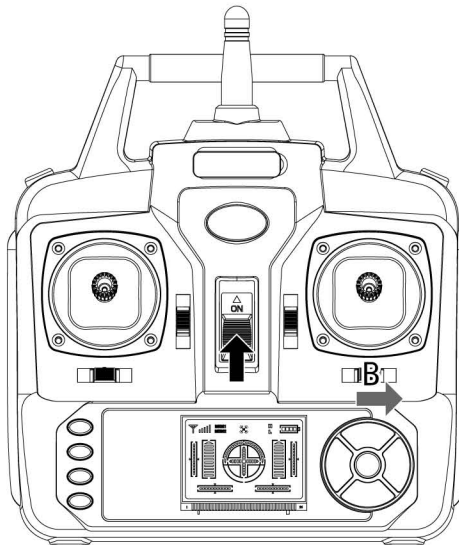

In order to satisfy the different operating habits of the consumers, this remote control is installed with two types of different operating modes, Mode 1 and Mode 2. Upon starting up, press Button B towards the right and switch on the power supply of the remote control simultaneously can toggle between Mode 1 and Mode 2.

Aircraft controlling diagram (mode 1 and default mode upon start-up)

Operating direction

Ascending and descending control

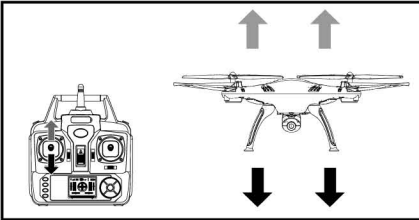

When the left joystick (Accelerator) is pushed upwards or downwards, the aircraft will ascend or descend correspondingly.

Forward and backward control



When the right joystick (Turning Rudder) is pushed upwards or downwards, the aircraft will advance forward or backward correspondingly.

Left turning and right turning control

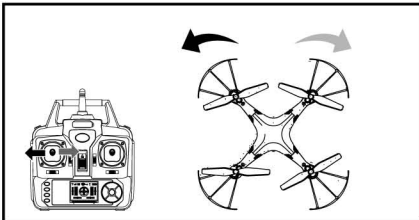

When the left joystick (Accelerator) is pushed towards the left or right, the aircraft will turn left or right correspondingly.

Left side flying and right side flying control

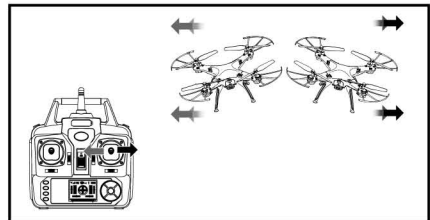

When the right joystick (Turning Rudder) is pushed towards the left or right, the aircraft will fly sideward on the left or right correspondingly.

Fine-tuning operation

Forward and backward fine-tuning control

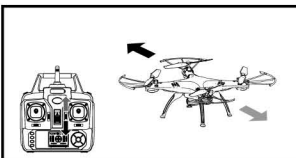

When the aircraft is hovering in the air, in the event that the aircraft is automatically advancing forward or backward, it can be rectified by pressing downwards or upwards the fine-tuning button correspondingly.

Left/right side flying fine-tuning control

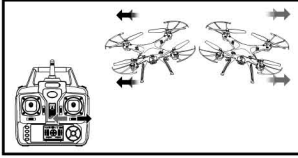

When the aircraft is hovering in the air, in the event that the aircraft is automatically flying sideward on the left or right, it can be rectified by pressing right or left on the fine-tuning button correspondingly.

Left/right side turning fine-tuning control

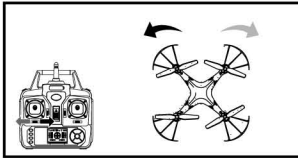

When the aircraft is hovering in the air, in the event that the aircraft is automatically turning left or right, it can be rectified by pressing right or left on the fine-tuning button correspondingly.

Aircraft controlling diagram (mode 2)

Operating direction

Ascending and descending control

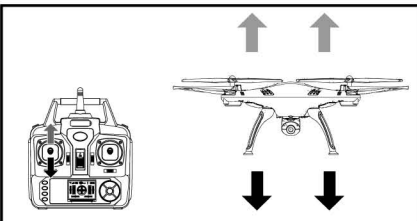

When the left joystick (Accelerator) is pushed upwards or downwards, the aircraft will ascend or descend correspondingly.

Forward and backward control

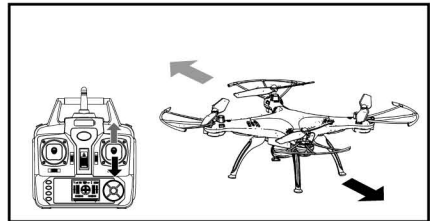

When the right joystick (Turning Rudder) is pushed upwards or downwards, the aircraft will advance forward or backward correspondingly.

Left turning and right turning control

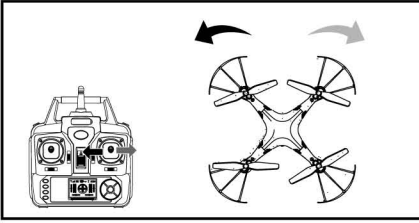

When the right joystick (Turning Rudder) is pushed towards the left or right, the aircraft will turn left or right correspondingly.

Left side flying and right side flying control

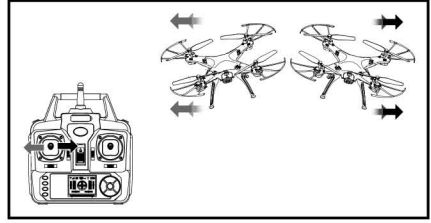

When the left joystick (Accelerator) is pushed towards the left or right, the aircraft will fly sideward on the left or right correspondingly.

Fine-tuning operation

Forward and backward fine-tuning control

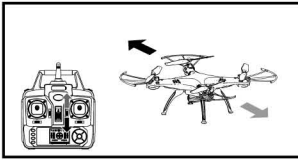

When the aircraft is hovering in the air, in the event that the aircraft is automatically advancing forward or backward, it can be rectified by pressing downwards or upwards the fine-tuning button correspondingly.

Left/right side flying fine-tuning control

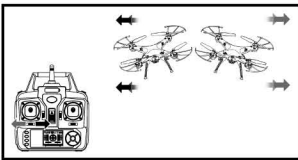

When the aircraft is hovering in the air, in the event that the aircraft is automatically flying sideward towards the left or right, it can be rectified by pressing right or left on the fine-tuning button correspondingly.

Left/right side turning fine-tuning control

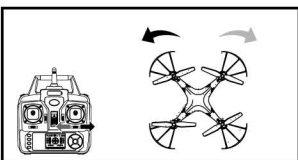

When the aircraft is hovering in the air, in the event that the aircraft is automatically turning left or right, it can be rectified by pressing right or left on the fine-tuning button correspondingly.

Flight preparation and switching off of the aircraft

I. Flight preparation

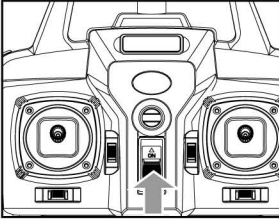

Step 1: Open up the power supply switch of the remote control.

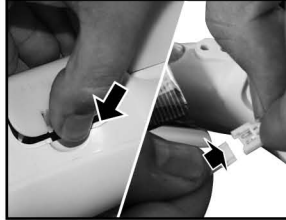

Step 2: Slide backwards the battery cover, and connect the battery connector with the power supply interface.

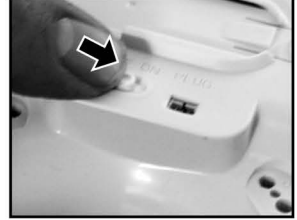

Step 3: Switch on the aircraft's switch at the bottom area.

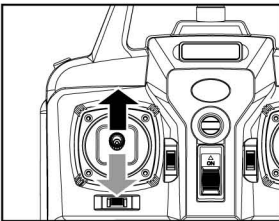

Step 4: Push the left lever (accelerator) to the highest point and then reset to the lowest point. When the indicator lights in the aircraft change from quick flashing to the continuous lighting, it means that the aircraft goes into the flight standby mode.

II. Switching on the aircraft

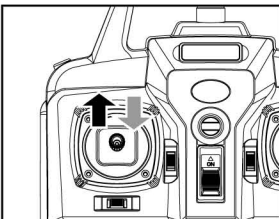

Method 1: push the left lever (accelerator) to the highest point and then reset to the center, the ventilation blade of aircraft starts rotating slowly.

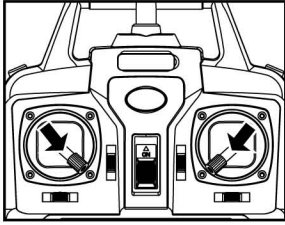

Method 2: Move the left and right joysticks inwards in an internal loop of “8” for 1 second, the ventilation blade of aircraft starts rotating slowly.

III. Switching off the aircraft

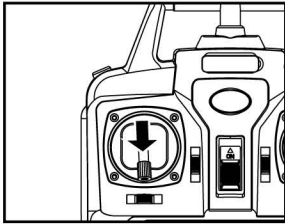

Method 1: Push the left joystick (Accelerator) to the lowest level and stay there for 2 to 3 seconds, the aircraft can then be switched off.

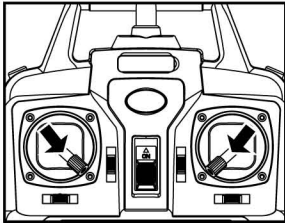

Method 2: Move the left and right joysticks inwards in an internal loop of “8” for 1 second, and the aircraft can be switched off.

Product features

I. Low-voltage protection:

When the four indicator lights at the bottom of aircraft start flicking, it means that the aircraft's battery power is low. At this time, the aircraft will initiate the height-limiting function and will drop to certain safety height.

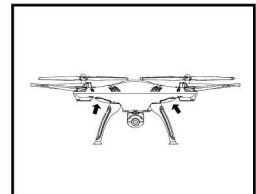

II. Overcurrent protection:

When the aircraft encounters direct impact from foreign object or is stuck under the circumstances in which its blades are rotating, the electric circuit of the aircraft will enter into the overcurrent protection mode.

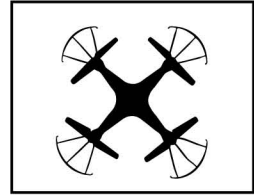

III. Level calibration function:

Place the aircraft on a levelling surface and at the same time, push both left and right joysticks to the lower right corners and stay there for 2 to 3 seconds; the normal light indicator on the aircraft will blink rapidly, and it will return back to the normal status after about 2 to 3 seconds. The level calibration is successful.

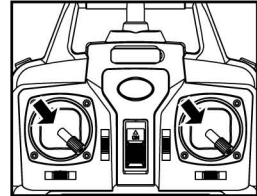

IV. 3D overturning function:

When you are familiar with the basic actions, you can proceed to explore even more exciting and risky overturning actions. Fly the aircraft to a height of above 3 m from the ground, press against the upper right corner button (Overturning Button) on the remote control and simultaneously push the right joystick to the highest level of Front/Back/Left/Right, the aircraft will now be executing the Front/Back/Left/Right overturning function.

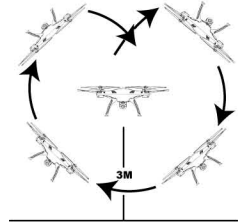

Note: When the batteries are fully charged, it will have the best overturning effect.

V. Pressure hovering height adjustment function:

After using the left joystick (Accelerator) to control the ascending / descending flight of the aircraft, free up the left joystick (Accelerator) and the aircraft will still hover at that height when the joystick is free.

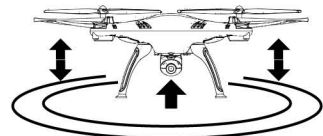

VI. Fling-flying action Instructions:

As the aircraft uses 6-axis gyro, it greatly increases the fun factor. Fling the aircraft outwards or overturning it upwards with a simultaneous stepping on the accelerator joystick, the aircraft can stop in the air in a steady manner.



VII. Headless function:

1. Defining forward direction:

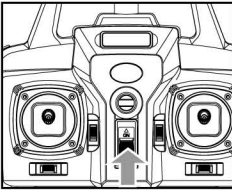

1. Open up the power supply switch of the remote control.

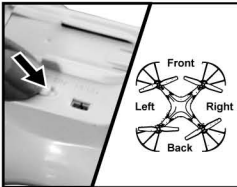

2. After connecting the aircraft to the power supply, push the switch to "ON" location, and adjust the specified direction of the aircraft's head under the headless mode as the new forward direction.

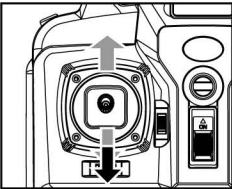

3. Push the accelerator joystick of the remote control to the highest level and then, pull back into the lowest level. When the remote control issues a long beep sound, it means the frequency and defining forward direction functions are completed.

2. Toggling between headless function and normal function:

1. When the aircraft has completed its matching of frequency, the default of the aircraft is normal mode.

At this time, the light indicator on the aircraft is in the long blinking mode. When pressing and holding on to the left upper corner of the headless function toggle button for 2 seconds, the remote control will issue a “Di, Di, Di,” sound indicating it has entered into the headless mode. In subsequent long pressing on the same button for 2 seconds, upon hearing a long “Di” sound, the aircraft has exited from the headless mode. In the headless mode, the four lights on the aircraft is slowly blinking. Every blink is within 4 seconds)

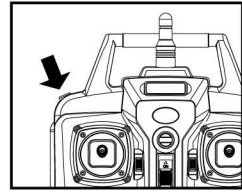

2. Under the headless mode, the operator does not require to differentiate the head position of the aircraft, and he just needs to control the aircraft using the joystick's direction of the remote control.

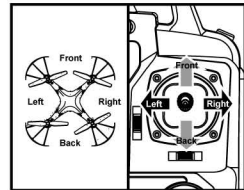

3. Rectification for the defining forward direction function:

1. When the aircraft encounters a direct impact with foreign objects in the headless mode, if there is an occurrence of deviation of the defined direction, it is only required to push the accelerator and the direction joystick to the left bottom corners simultaneously after rectifying the flying direction of the aircraft in the correction direction. When the light indicator of the aircraft is in a long “ON” mode after slowly blinking for 3 seconds, it indicates the rectification is complete.

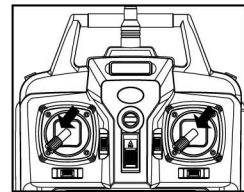

Battery changing and charging methods for aircraft

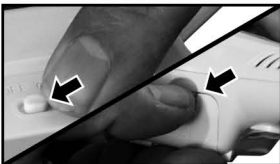

1. Push the switch button of aircraft to “OFF”, and press against the battery cover and slide backwards.

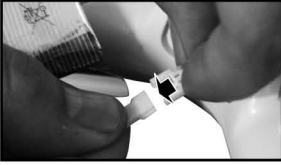

2. Disconnect the connection joint of the battery from the connection interface of the power supply.

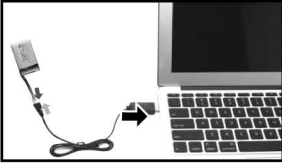

3. Connect the power supply line of the battery with USB, and connect the USB interface with the computer's connection port (During charging, the light indicator will light up; and the light indicator will go off when it is fully charged. The completion time for charging the battery is less than 130 minutes).



4. After changing the batteries, firmly secure the battery cover again.

The charging time is less than 130 minutes; In hover flight conditions longer than 7.5 minutes!

Precautions as follows during charging of battery:

- Avoid placing the active batteries in places with direct exposure, sunlight and high temperatures. For example, naked light or electrical equipment installations; otherwise it may cause damages or explosions.
- Avoid immersing the batteries in the water. The batteries shall be stored in a cool and dry place.
- Avoid dismantling the batteries.
- During the charging of battery, avoid leaving the charging place.
- Risk of explosion if battery is replaced by an incorrect type. Dispose of used batteries according to the instructions.
- The following instructions were NOT marked.
- Rechargeable batteries are to be removed from the toy before being charged. Rechargeable batteries are only to be charged under adult supervision.
- Exhausted batteries are to be removed from the toy.

- Transformers used with the toy are to be regularly examined for damage to the cord,plug,enclosure and other parts,and that,in the event of such damage,the toys must not be used with this transformer until the damage has been repaired.
- **Warning!** The toy is to be assembled by an adult.
- Rechargeable batteries are to be removed from the toy before being charged .
- Rechargeable batteries are only to be charged under adult supervision .
- Exhausted batteries are to be removed from the toy.
- After the battery cover of remote controller is opened by the tool (screw driver), 4 AA batteries are correctly installed according to the positive and negative electrode. Then, the battery cover is closed. Finally, the screw driver is used to screw down the battery cover. The aircraft should be connected with 500mAh and 3.7V lithium battery after the battery cover is opened manually. Then, the battery cover is closed manually.

Wifi camera installation and dismantling methods

Wifi camera dismantling procedures:

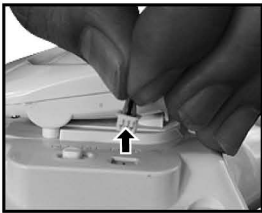

Figure (1)

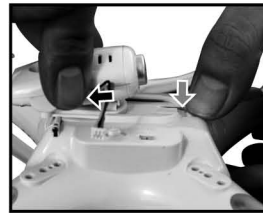

Figure (2)

1. Remove the 3-line plug into the camera connection interface of the main body according to Figure (1).
2. Use strength to press against the safety catch of the main body and at the same time, pull the camera backwards according to Figure (2).

Wifi camera installation procedures:

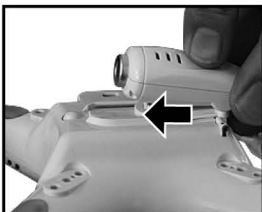

Figure (1)

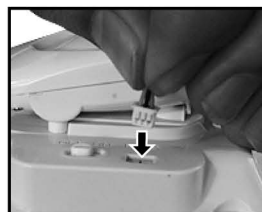

Figure (2)

1. When the camera is aligned with the main body's connector, push the camera inwards according to Figure (1).
2. Insert the 3-line plug into the camera connection interface of the main body according to Figure (2).

Rectification procedures

Problem	Reason	Solution
The aircraft has no response	<ol style="list-style-type: none"> 1. The aircraft has entered into lowvoltage protection. 2. When the power of the remote control is weak, the power light indicator will blink. 3. The channel selection of the remote control does not match with the aircraft's coding. 	<ol style="list-style-type: none"> 1. Charge up the aircraft. 2. Change the batteries of the remote control. 3. Adjust the channel of both the remote control and aircraft such that they are in synchronized mode.
The flight response of the aircraft is not sensitive	<ol style="list-style-type: none"> 1. The power of the remote control is weak. 2. There is an interference with the same frequency as that of the remote control. 	<ol style="list-style-type: none"> 1. Change the batteries. 2. Change to a place where there is no interference with the same frequency.
The aircraft is flying towards its side in one direction during hovering	<ol style="list-style-type: none"> 1. The aircraft is not calibrated level to the ground. 	<ol style="list-style-type: none"> 1. Re-adjust the calibration until the aircraft is level to the ground. For further details, please refer to Point III of Page 13 (Level Calibration Function).
In the headless state, it is biased towards the front direction	<ol style="list-style-type: none"> 1. Many collisions may cause head biasness. 	<ol style="list-style-type: none"> 1. Re-define the front direction. For further details, please kindly refer to Point VII of Page 14 and 15 (Headless Function).

Accessories (Optional)

You can choose your favourite optional accessories as below. In order to make it easier for the customers to choose and purchase, we have specially offered each and every accessory. The accessories can be purchased through the local distributors. Please kindly specify the colours during your purchase.



X5HW-01A
Main Body
(White)



X5HW-01B
Main Body
(Blue)



X5HW-02
Rotor Blade
(Black)

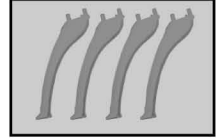

X5HW-03A
Base Stand
(Green)

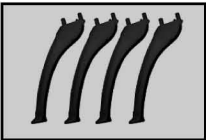

X5HW-03B
Base Stand
(Black)

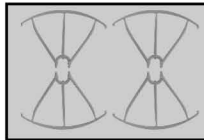

X5HW-04A
Protective
Gear (Green)

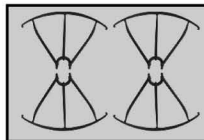

X5HW-04B
Protective Gear
(Black)



X5HW-05
Mobile Phone
Fixed Mounting



X5HW-06
Motor A
(Red and
blue lines)



X5HW-07
Motor B
(Black and
white lines)

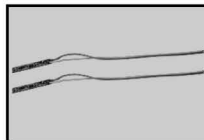

X5HW-08
Light Bar

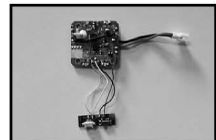

X5HW-09
Receiver
Board



X5HW-10
Lamp Cover



X5HW-11
Battery



X5HW-12
USB Cable

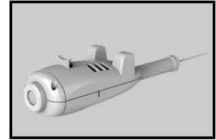

X5HW-13A
WIFI Camera (White)

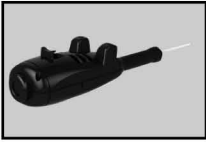

X5HW-13B
WIFI Camera (Black)



X5HW-14
Remote Control

Product descriptions

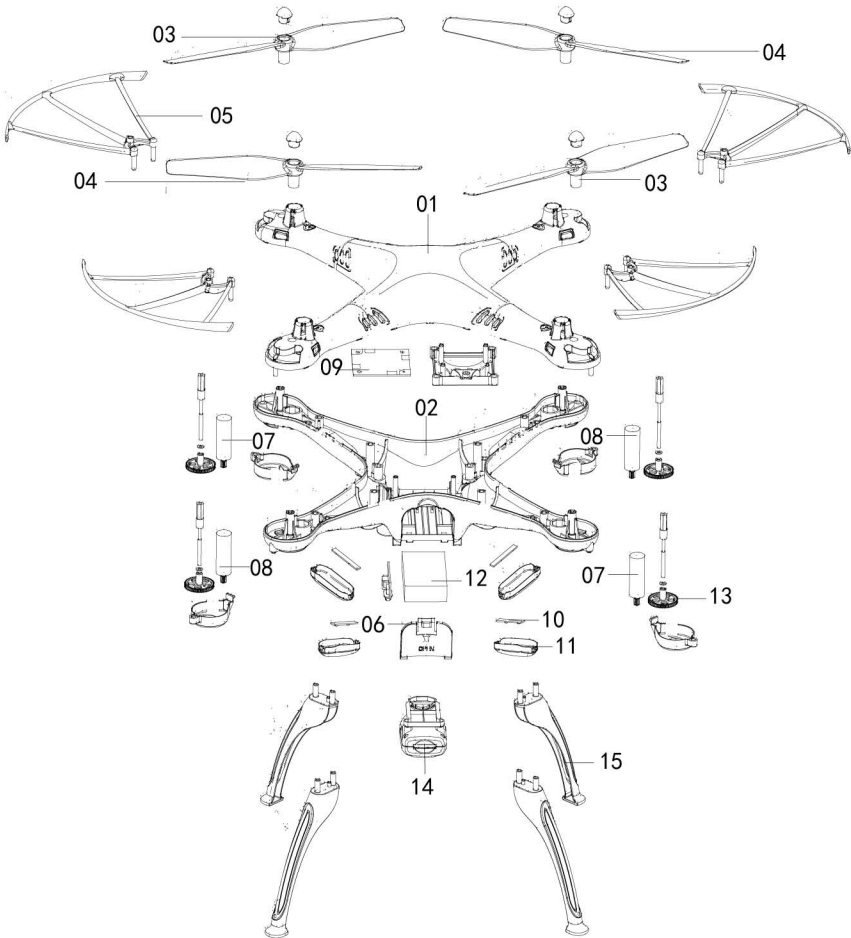

NO.	Product Name	Qty.	NO.	Product Name	Qty.
01	Top Main Body	1	09	Circuit Board	1
02	Bottom Main Body	1	10	Lamp Cover	4
03	Main Blade(Clockwise Direction)	2	11	Light Bar	4
04	Main Blade(Anti-clockwise Direction)	2	12	Battery	1
05	Protective Gear	4	13	Gear Box	4
06	Battery Cover	1	14	Camera	1
07	Main Motor(Clockwise Direction)	2	15	Foot Stand	4
08	Main Motor(Anti-clockwise Direction)	2			

Main specifications

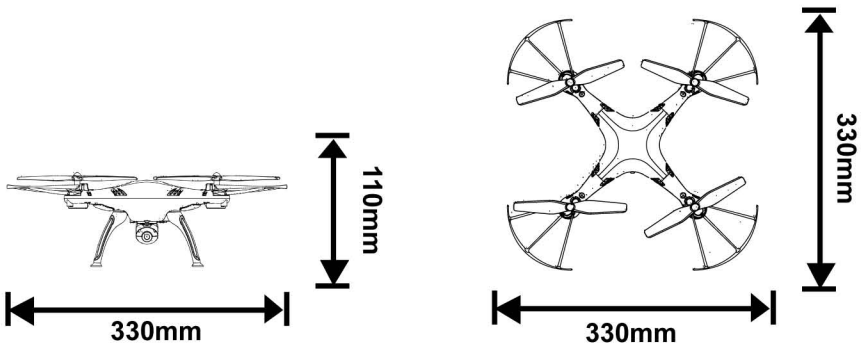

Aircraft's Length:330mm Aircraft's Width:330mm

Aircraft's Height:110mm Motor's Model: Ø8

Battery: 3.7V/500mAh lithium battery



SPECIFICATIONS AND COLORS OF CONTENTS MAY VARY FROM PHOTO.



**Two-dimension code
of Android system**



**Two-dimension code
of iPhone iOS system**

**The company has the right of final interpretation
of this instruction manual statement.**