



User Manual



## 3DR Support

Contact 3DR Support for questions and technical help.

online: **3dr.com/support**

email: **support@3dr.com**

call: **+1 (858) 225-1414** (direct)

**+1 (855) 982-2898** (toll free in the US and Canada)

Support line hours:

Mon-Fri 8 am to 5 pm PST

3D Robotics (3DR)  
1608 4th Street, Suite 410  
Berkeley, CA 94710  
Tel. +1 (858) 225-1414  
3dr.com

Solo User Manual V9  
© 2015 3D Robotics Inc.  
Solo is a trademark of 3D Robotics, Inc.

GoPro, HERO, the GoPro logo, and the GoPro Be a HERO logo are trademarks or registered trademarks of GoPro, Inc.

# 1 Contents

<b>1</b>	<b>Introduction</b>	<b>1</b>
1.1	System Overview	1
1.2	Aircraft Overview	2
1.3	Controller Overview	3
1.4	Operating Parameters	4
1.5	Autopilot	5
1.6	Propulsion	5
1.7	LED Meanings	5
<b>2</b>	<b>Setup</b>	<b>6</b>
2.1	In the Box - Solo with The Frame	6
2.2	In the Box - Solo with 3-Axis Gimbal	6
2.3	Battery	6
2.4	Controller	8
2.5	Propellers	9
2.6	Camera	10
2.7	Mobile App	11
<b>3</b>	<b>The Solo Gimbal</b>	<b>16</b>
3.1	In the Box	16
3.2	Gimbal Installation	16
3.3	Gimbal Operation	22
<b>4</b>	<b>Safety</b>	<b>25</b>
4.1	Location	25
4.2	Environmental Awareness	25
4.3	Visual Line of Sight	25
4.4	Flight School	26
4.5	Propellers	26
4.6	GPS	26
4.7	Home Position	27
4.8	Altitude Limit	27
4.9	Emergency Procedures	27
4.10	Flight Battery	28
4.11	Controller	28
4.12	Antenna Configuration	29
<b>5</b>	<b>First Flight</b>	<b>30</b>
5.1	Preflight Checklist	30
5.2	Takeoff	30
5.3	Landing	31
5.4	Return Home	32
5.5	In-Flight Data	34
5.6	Joystick Control	35
<b>6</b>	<b>Using the Solo App</b>	<b>38</b>
6.1	App Interface Overview	38
6.2	Smart Shots	47
6.3	Selfie	48
6.4	Cable Cam	50
6.5	Orbit	55
6.6	Follow	57

<b>7</b>	<b>Alerts</b>	<b>60</b>
7.1	Preflight Errors	60
7.2	In-Flight Errors	61
<b>8</b>	<b>Advanced Settings</b>	<b>65</b>
8.1	Advanced Flight Modes	65
8.2	Enabling Advanced Flight Modes	66
8.3	Accessing Advanced Flight Modes	66
8.4	Home Position Safety	66
8.5	Performance Adjustment	66
8.6	Units	67
8.7	Maximum Altitude Adjustment	67
8.8	Map Tile Provider (Android only)	67
<b>9</b>	<b>Support</b>	<b>68</b>
<b>10</b>	<b>Maintenance</b>	<b>69</b>
10.1	Controller Battery Replacement	69
10.2	Calibrations	69
10.3	Pairing the Controller	70
10.4	Legs	71
10.5	Battery Tray	75
10.6	Motor Mods	76
10.7	Factory Reset	78
<b>11</b>	<b>Appendix</b>	<b>80</b>
11.1	Specifications	80
11.2	Warranty	81
11.3	Regulatory Compliance	81

# 1.1 Figures

Figure 1.1.3.1: Solo System Context Diagram	1
Figure 1.2.4.1: Solo Overview	2
Figure 1.3.10.1: Controller Overview	4
Figure 1.4.1: Solo Operating Parameters	4
Figure 1.6.1: Solo Motor Order	5
Figure 2.1.1: Solo Parts	6
Figure 2.2.1: Solo with 3-Axis Gimbal Parts	6
Figure 2.3.1.1: Charging the Solo Smart Battery	7
Figure 2.3.2.1: Powering Solo	8
Figure 2.4.1.1: Controller Charging	8
Figure 2.4.2.1: Power On Controller	9
Figure 2.5.1.1: Attach Propellers	9
Figure 2.6.1.1: Attach Camera	10
Figure 2.6.2.1: Camera Configuration Process	10
Figure 2.7.3.1: Connect to Solo Link	11
Figure 2.7.4.1: App - Settings Menu	11
Figure 2.7.4.2: App - Wi-Fi Settings	12
Figure 2.7.5.1: Controller Preflight Update Prompt	12
Figure 2.7.5.2: App - Software Update	12
Figure 2.7.5.3: App - Connecting Instructions	12
Figure 2.7.5.4: App - Instructions List	13
Figure 2.7.5.5: App - Download Update	13
Figure 2.7.5.6: App - Start Update	13
Figure 2.7.5.7: Controller - Updating	13
Figure 2.7.5.8: App - Update Disconnection Confirmation	14
Figure 2.7.5.9: Controller Update Complete Displays	14
Figure 2.7.5.10: Controller - Waiting for Solo	14
Figure 2.7.5.11: App - Update Success	14
Figure 2.7.6.1: App - Viewing Video	15
Figure 3.1.1: Solo Gimbal Parts	16
Figure 3.2.1.1: Removing The Frame	17
Figure 3.2.2.1: Connecting cables	17
Figure 3.2.3.1: Positioning the Gimbal Cable	18
Figure 3.2.3.2: Positioning the HDMI Cable	18
Figure 3.2.4.1: Mounting the Gimbal	19
Figure 3.2.5.1: HDMI Plug Positioning	19
Figure 3.2.5.2: Attach GoPro	20
Figure 3.2.5.3: Fasten Camera	20
Figure 3.2.6.1: GoPro Weight Balancing	20
Figure 3.2.7.1: Adding the Sunshade	21
Figure 3.2.9.1: Camera Configuration Process	22
Figure 3.3.1.1: Gimbal Controls	22
Figure 3.3.2.1: LED Gimbal Signal	23
Figure 4.4.1: App Flight School	26
Figure 4.9.5.1: Controller - Motor Shutoff	28
Figure 4.12.1: Controller Antenna Orientation	29
Figure 5.2.1.1: Controller - Start Motors Prompt	30
Figure 5.2.2.1: Controller - Takeoff Prompts	31
Figure 5.3.1: Controller - User-Initiated Landing	31
Figure 5.4.1: Return Home Button	32
Figure 5.4.1.1: The Cone Zone	32
Figure 5.4.2.1: Above Return Home	33
Figure 5.4.2.2: Within the Cone	33
Figure 5.4.2.3: Below Return Home and Outside the Cone	34
Figure 5.5.1: Controller - In-Flight Data	34
Figure 5.6.1: Controller Left Joystick	35
Figure 5.6.2: Throttle Joystick Behaviors	35
Figure 5.6.3: Yaw Joystick Behavior	36

Figure 5.6.4: Controller Right Joystick Controls	36
Figure 5.6.5: Pitch Joystick Controls	37
Figure 5.6.6: Roll Joystick Controls	37
Figure 6.1.1: Solo App Home Screen	38
Figure 6.1.1.1: App - Plan your flight screen	39
Figure 6.1.1.2: App - Planning map zoomed out	39
Figure 6.1.1.3: App - Proscribed area description	39
Figure 6.1.1.4: App - List of proscribed locations	40
Figure 6.1.1.5: App - Filters	40
Figure 6.1.2.1: App - Main Interface	42
Figure 6.1.2.2: Advanced telemetry data	42
Figure 6.1.3.1: Initial Map Screen	43
Figure 6.1.3.2: Map Screen During Caching	43
Figure 6.1.4.1: Camera button states	44
Figure 6.1.4.2: Tap for Camera Settings	45
Figure 6.1.4.3: In-App Camera Settings	45
Figure 6.1: App - Main Screen	47
Figure 6.2: App - Shot List	47
Figure 6.3.1: Selfie Path and Settings	48
Figure 6.3.1.1: App - Selfie Activation	48
Figure 6.3.2.1: App - Selfie Control	49
Figure 6.3.2.2: Controller - Selfie Control	49
Figure 6.3.3.1: App - Selfie Settings	49
Figure 6.4.1.1: App - Cable Cam Setup	50
Figure 6.4.2.1: App - Cable Cam Controls	51
Figure 6.4.2.2: Controller - Cable Cam Controls	51
Figure 6.4.3.1: App - Cable Cam Settings with Time Lapse off	52
Figure 6.4.3.2: App - Cable Cam Settings with Time Lapse on	52
Figure 6.4.4.1: App - Cable Cam Smart Shots screen	53
Figure 6.4.4.2: App - Cable Cam Smart Shots screen	53
Figure 6.4.5.1: App - Selecting Saved Shots for Deletion	54
Figure 6.4.6.1: App - Prompt to Correct Solo Position	54
Figure 6.4.6.2: App - Prompt to load saved Cable Cam sequence	55
Figure 6.5.1.1: App - Orbit Setup	56
Figure 6.5.2.1: App - Orbit Controls	56
Figure 6.5.2.2: Orbit Controls	56
Figure 6.5.3.1: App - Orbit Settings	57
Figure 6.6.1.1: Follow in Look At Me mode	58
Figure 6.6.1.2: Follow in Follow mode	58
Figure 6.6.2.1: Follow Controls	58
Figure 6.6.3.1: App - Follow Settings	59
Figure 6.6.3.2: App - Free Look warning	59
Figure 7.1.1.1: Controller - Calibration in Progress Alerts	60
Figure 7.1.1.2: Controller - Uneven Surface Alert	60
Figure 7.1.1.3: Controller - Re-Calibration Required Alerts	60
Figure 7.1.1.4: Controller - Calibration Error Alert	61
Figure 7.1.2.1: Controller - Service Alerts	61
Figure 7.2.1.1: Controller - Altitude Limit Alert	61
Figure 7.2.2.1: Controller - App Connection Alerts	62
Figure 7.2.3.1: Controller - Controller Disconnected Alert	62
Figure 7.2.3.2: Controller - Controller Signal Alerts	62
Figure 7.2.4.1: Controller - GPS Signal Alerts	63
Figure 7.2.5.1: Controller - Low Battery Alerts	63
Figure 7.2.5.2: Controller - Critical Battery Alert	63
Figure 7.2.6.1: Controller - Controller Battery Alerts	64
Figure 8.2.1: App - Advanced Settings	66
Figure 8.3.1: App - A and B Presets	66
Figure 8.5.1: App - Performance Sliders	67
Figure 8.6.1: App - Change Units	67
Figure 8.7.1: App - Altitude Limit	67

Figure 9.1: App - Submit Trouble Ticket	68
Figure 10.1.1: Controller Battery Installation	69
Figure 10.2.1.1: App - Compass Calibration Setup	69
Figure 10.2.1.2: App - Compass Calibration Procedure	70
Figure 10.2.2.1: App - Level Calibration	70
Figure 10.3.1: Pair Button	70
Figure 10.3.2: Detected Solo	71
Figure 10.3.3: Solo Paired	71
Figure 10.4.1: Leg Types	71
Figure 10.4.1.1: Standard Leg Replacement Process	72
Figure 10.4.2.1: Detaching the Antenna from the Leg	72
Figure 10.4.2.2: Attaching a New Leg with an Existing Antenna	72
Figure 10.4.2.3: Attaching an Existing Antenna to a New Leg	73
Figure 10.4.3.1: Compass Connector on Mainboard	73
Figure 10.4.3.2: Insert New Leg with Compass	74
Figure 10.5.1.1: GPS Cover Removal	75
Figure 10.5.2.1: Battery Tray Removal	75
Figure 10.5.2.2: Battery Tray Detachment	75
Figure 10.6.1: LED Cover Removal	76
Figure 10.6.2: Motor Pod Removal	76
Figure 10.6.3: Motor Pod Disconnection	77
Figure 10.6.4: Motor Pod Connection	77
Figure 10.6.5: Motor Pod and LED Cover Attachment	77
Figure 10.7.1: Pair Button	78
Figure 10.7.2: Strobing Pairing Light	78
Figure 10.7.3: Controller Reset	79
Figure 10.7.4: Controller Update	79
Figure 10.7.2.5: Controller Screen After Reset	79

# 1 Introduction

We designed Solo to be the perfect aerial-video tool. It's powerful, simple and reliable with intuitive Smart Shots inspired by our favorite cinema pilots. With Solo, you don't need a professional camera crew, you can get the perfect shot every time. We're excited to share our passion with you and help you see your world from a new perspective. Join us in capturing the next evolution of creative videography

## 1.1 System Overview

The Solo system includes Solo, the Controller, and the Solo App. As the operator, you interact with the controller and app on the ground, and the controller communicates with Solo during flight.

### 1.1.1 Solo

Solo is a small unmanned aerial vehicle (UAV) powered by four motors and four propellers. Solo's onboard computers control navigation, attitude, and communications in flight while sending real-time telemetry and video output and receiving control inputs over the 3DR Link secure Wi-Fi network. Solo is optimized for capturing aerial video using a GoPro® HERO camera.

### 1.1.2 Controller

The controller provides control mechanisms and displays in-flight data on a full-color screen. Using twin long-range antennas, the controller acts as the central hub for all communication on the 3DR Link network, receiving all communications from Solo and the app, forwarding telemetry outputs to the app, and managing the transmission of all control inputs to Solo.

### 1.1.3 App

The Solo App outputs a live video stream from an onboard GoPro® camera to an Android or iOS device. The App allows you to view the live video with overlaid telemetry and access a simplified graphic interface for controlling Solo's advanced functions. The App also connects to the 3DR SoloLink network to receive video and telemetry outputs and send control inputs.

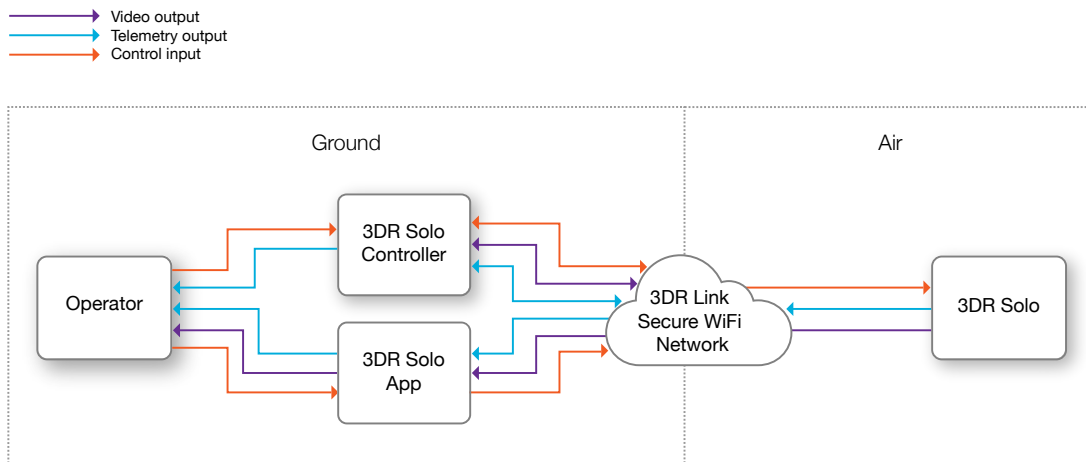

Figure 1.1.3.1: Solo System Context Diagram

### 1.1.4 3-Axis Gimbal

The 3-Axis Solo Gimbal provides greater control of GoPro® HERO cameras. The Gimbal is included, fully installed, in the package **Solo with 3-Axis Gimbal** and is also available separately for Solo. This powerful accessory is fully covered in Chapter 3 of this manual.



## 1.2 Aircraft Overview

### 1.2.1 Smart Battery

The battery connects to Solo's battery bay. Solo's power button is located on the battery; Solo can be powered only when the battery is connected.

### 1.2.2 Motors and Propellers

Solo's arms are labeled 1 through 4 on the ends of the arms. Motors on arms #1 and #2 spin counterclockwise and use clockwise-tightening propellers with silver tops. Motors on arms #3 and #4 spin clockwise and use counterclockwise-tightening propellers with black tops.

### 1.2.3 Orientation LEDs

Each arm contains an LED for ground-to-air directional awareness; when armed for flight, the two front arms (#1 and #3) display white, and the two rear arms (#2 and #4) display red. This LED scheme mimics the headlight and taillight style of a car.

### 1.2.4 Fixed Camera Mount and HDMI Cable

Solo includes a GoPro® The Frame fixed mount to mount a GoPro® HERO camera. The HDMI cable connects to the GoPro® to output video during flight.

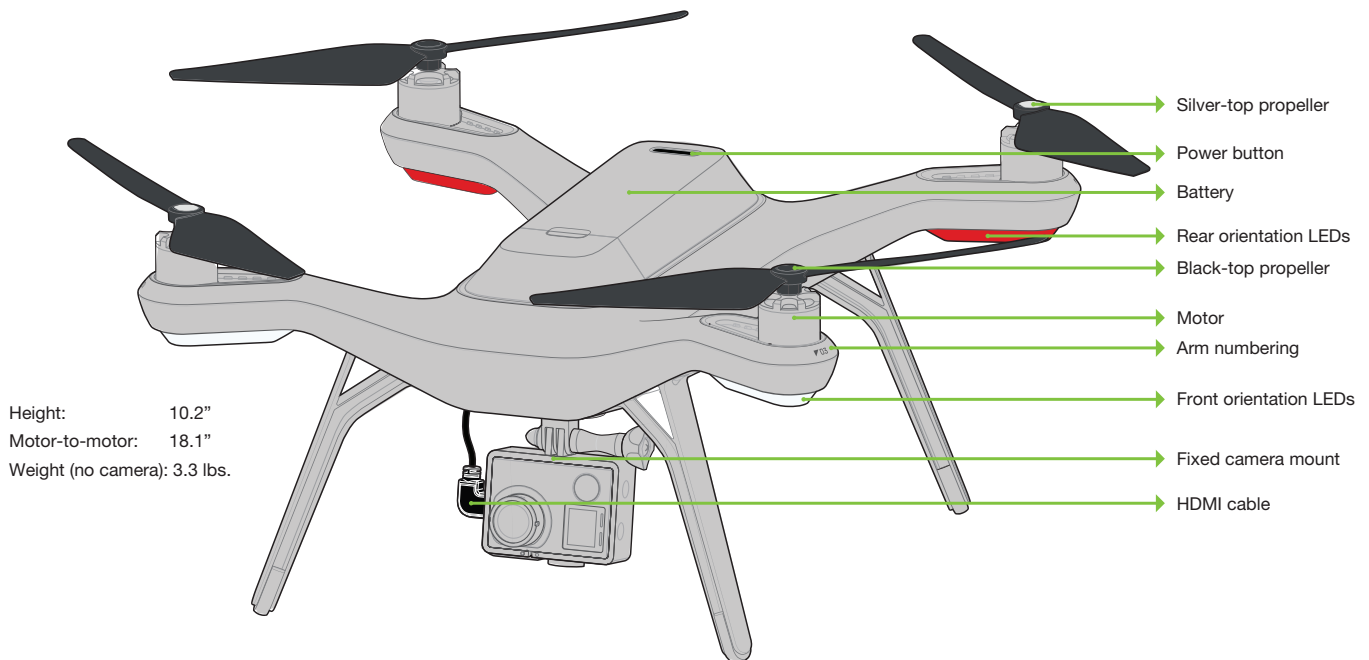

Figure 1.2.4.1: Solo Overview

## 1.3 Controller Overview

### 1.3.1 Mobile-Device Holder

Mount an Android or iOS device to run the Solo App and effortlessly integrate the App into the controller's operational flow. A user-supplied smartphone or tablet is required to initialize Solo and use Smart Shots.

### 1.3.2 Joysticks

The controller's left and right joysticks provide direct manual control of Solo and physical control mechanisms for use with Smart Shots.

### 1.3.3 Screen

The controller's full-color screen provides live in-flight data and prompts for certain Solo functions.

### 1.3.4 Power Button

Press the power button once to check the controller's battery level. Hold the power button until you see the controller startup screen to power on the controller.

### 1.3.5 Fly Button

The Fly button lets you control Solo's main flight functions: starting motors, takeoff, land, and activating GPS flight.

### 1.3.6 Return Home

The Return Home button allows you to end your flight automatically at any point by returning Solo to its original launch point and landing.

### 1.3.7 Pause Button

The Pause button is Solo's emergency air brake. Press Pause to stop Solo and hover in place at any time.

### 1.3.8 Option Buttons

The A and B buttons change functionality based on where you are in the operational flow. The screen shows the currently assigned functions of A and B at all times. You can program A and B to specific functions using the App. By default, the A button is assigned to Cable Cam and the B button is assigned to Orbit.

### 1.3.9 Antennas

The controller's long-range dipole antennas communicate with Solo during flight. See Section 4.12 for proper antenna configuration.

### 1.3.10 Gimbal Controls

Use the paddle, buttons, and dial on the top of the controller are used to control the Solo Gimbal. You can also use them in some Smart Shots.

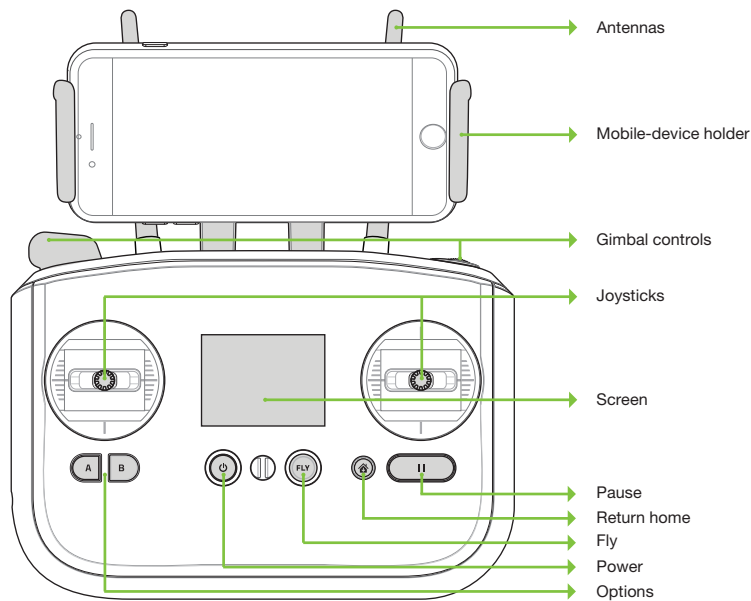

Figure 1.3.10.1: Controller Overview

## 1.4 Operating Parameters

The following operating parameters apply to Solo. Always operate Solo within these parameters. Solo's performance and behaviors may vary significantly if flying in that conditions violate the parameters listed below.

Estimated flight time	up to 25 minutes*
Default maximum altitude	150 ft. (46 m) above ground level**
Range	.5 mile*** (.8 km)
Payload capacity	1 lb. (450 g)
Cruise speed	18 mph (8 m/s)
Maximum speed	33 mph (15 m/s)****
Wind speed limitation	25 mph (11 m/s)
Operating temperature	32° F - 113° F (0° C to 45° C)

Figure 1.4.1: Solo Operating Parameters

\* Flight time varies with payload, wind conditions, elevation, temperature, humidity, flying style, and pilot skill. Listed flight time applies to elevations less than 2,000 ft above sea level.

\*\* To adjust maximum altitude, see Section 8.7.

\*\*\* Depending on environmental conditions

\*\*\*\* This top speed corresponds to Solo when operating in Fly mode. Maximum speeds for advanced modes may vary; see Section 8.1 for more information.

## 1.5 Autopilot

Solo uses a Pixhawk 2 autopilot running ArduPilot Copter software. ArduPilot is open-source flight control based on the MAVlink communication protocol. Pixhawk 2 runs an ARM Cortex-M4 STM32F427 processor with 2 MB of flash memory and 256 KB of RAM. Combined with an array of CAN, I2C, SPI, PWM, and UART interfaces, Pixhawk 2 uses a suite of onboard sensors to calculate Solo's orientation and motion in flight. This data is input into ArduPilot's inertial navigation and position-estimation algorithms and combined with control inputs to send commands to Solo's propulsion system.

## 1.6 Propulsion

Solo uses four brushless 880 K<sub>v</sub> motors and four self-tightening propellers for propulsion. For control and aerodynamic efficiency, two motors spin clockwise and two motors spin counterclockwise. Navigation in the air is achieved by mixing propulsion of the four motors to actuate flight control along the roll, pitch, and yaw axes.

Each of the four motors is numbered by the marking on the arm. These numbers correspond to the autopilot calculations for these ESC commands and are used for indicating motor replacement procedures. Each motor is controlled by an ESC (Electronic Speed Controller) that regulates the rotation of the motors to achieve the speed commanded by the autopilot.

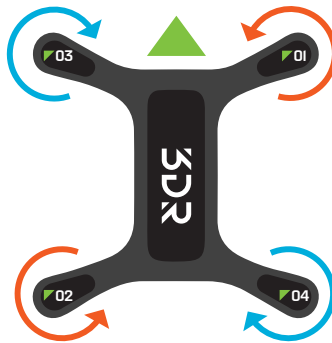

Figure 1.6.1: Solo Motor Order

## 1.7 LED Meanings

Solo's four LEDs indicate its status during startup and in flight.

- Solid white (front) and red (back): Ready to fly, standard flight configuration
- Pulsing white (front) and red (back): Solo is flying under autopilot control
- Flashing red alternating front and back: Controller signal lost
- Flashing rainbow: Update in progress
- Solid green, then turning off one-by-one: Startup successful
- Solid green without turning off automatically: Startup unsuccessful, please restart Solo

## 2 Setup

This section covers everything you need to set up Solo out of the box.

### 2.1 In the Box - Solo with The Frame

The Solo package includes the Solo Vehicle with The Frame (for mounting a GoPro camera), the Solo Controller, propellers (four plus two spares), the Solo Smart Battery, the Solo Smart Battery charger, and a charger for the Solo Controller.

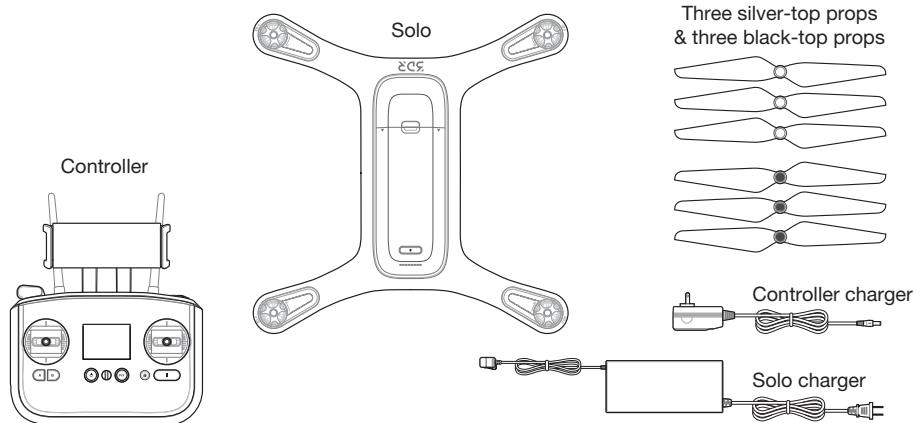

Figure 2.1.1: Solo Parts

### 2.2 In the Box - Solo with 3-Axis Gimbal

The Solo with 3-Axis Gimbal package includes the Solo Vehicle with 3-Axis Gimbal installed, the Solo Controller, propellers (four plus four spares), the Solo Smart Battery, the Solo Smart Battery charger, and a charger for the Solo Controller.

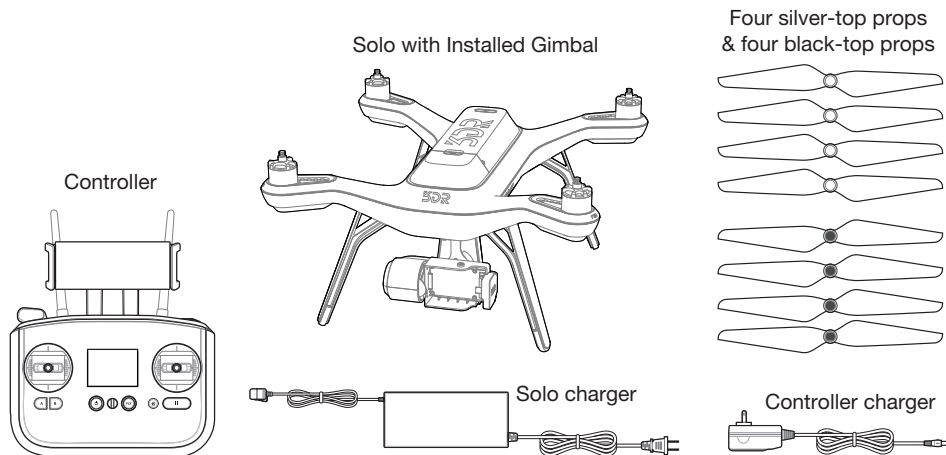

Figure 2.2.1: Solo with 3-Axis Gimbal Parts

### 2.3 Battery

Solo is powered by the rechargeable Solo Smart Battery, which provides up to 25 minutes of flight time per full charge. (Note: Flight time depends on payload, wind conditions, elevation, temperature, humidity, flying style and

pilot skill, so the actual flight time may vary.) As a lithium polymer battery, the Solo Smart Battery requires specific handling practices to ensure safe operation and prevent accidents. For more information about battery safety, see Section 4.10, Flight Battery, on page 28.

### 2.3.1 Charging

The level of the battery charge is indicated by the lights below the power button. Press the power button once to display the current power level. The Solo Smart Battery ships with approximately 50% charge, so charge fully before your first flight for maximum flight time.

Remove the battery from Solo before charging by holding the release button and sliding the battery towards the back of Solo. Charge the battery using the designated Solo charger only; using a different charger can damage the battery or cause a fire.

To charge the battery, connect the Solo charger to the battery and a wall outlet. While charging, the indicator lights pulse at the current level. An additional indicator on the battery charger turns from red to green when the battery is fully charged. The battery takes approximately 1.5 hours to charge to 100%. The optimal storage charge for the Solo Smart Battery is 50%. Storing the Solo Smart Battery at an excessively depleted charge (7 percent and under) for an extended period might result in shorter battery life or permanent damage to the battery.

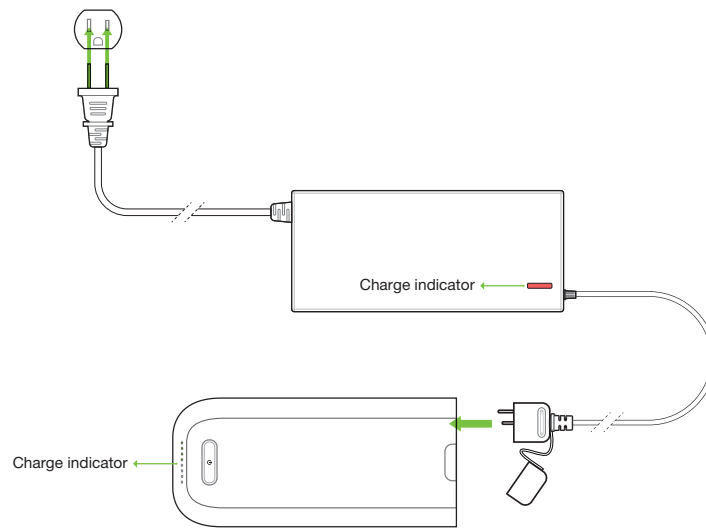

Figure 2.3.1.1: Charging the Solo Smart Battery

### 2.3.2 Powering

To power Solo, insert the Smart Battery into Solo's battery bay and slide the battery forward until it clicks into place. To turn on Solo, press and hold the battery power button. When Solo powers on, the battery displays an LED animation and you hear the startup tone. Power Solo only with the designated 3DR Solo Smart Battery; using a different battery can permanently damage Solo.



Before powering on, make sure Solo is level and keep Solo still during startup and while the sensors initialize. Moving Solo during this process causes the sensors to calibrate incorrectly and can create a preflight error or affect in-flight performance.

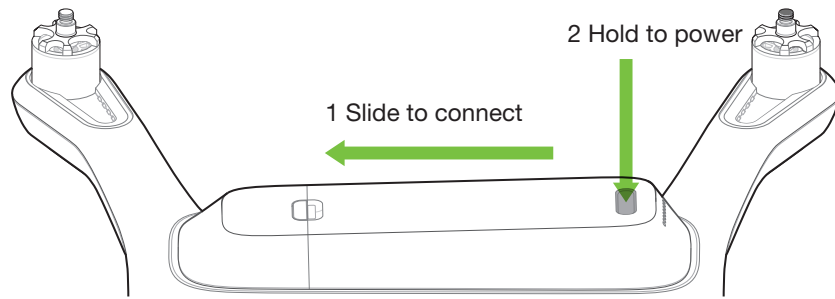

Figure 2.3.2.1: Powering Solo

## 2.4 Controller

The Solo Controller includes a pre-installed rechargeable lithium ion (Li-ion) battery.

### 2.4.1 Charging

Charge the controller using the designated controller charger only; using a different charger can damage the controller or cause a fire.

To charge the controller, connect the controller charger to the barrel jack on the side of the controller and to a wall outlet. To check the battery level of the controller, press the power button. A fully charged controller lasts for approximately 6 hours. Always check the controller's battery level before you fly, and recharge when prompted by the controller. The controller takes approximately three hours to charge to 100%.

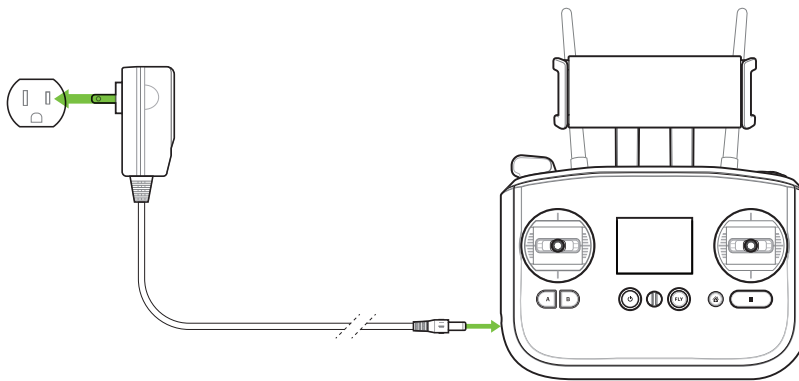

Figure 2.4.1.1: Controller Charging

## 2.4.2 Powering

To power on the controller, press and hold the controller power button until you see the startup screen.

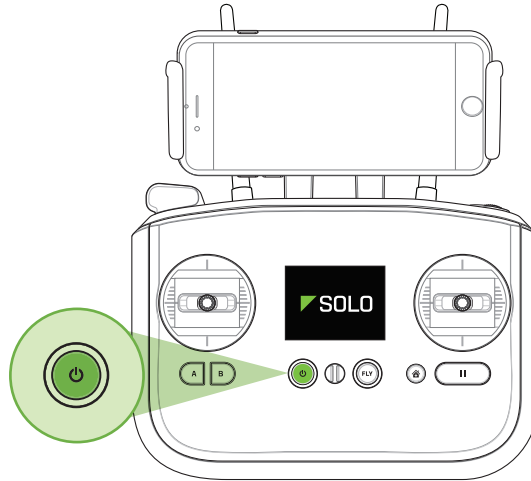

Figure 2.4.2.1: Power On Controller

## 2.5 Propellers

Solo uses two types of self-tightening propellers, indicated by the color of the circle at the center of the propeller.

### 2.5.1 Attaching

Attach the propellers with silver tops to the motors with a silver dot on the top of the motor shaft, and attach the black-top propellers to the motors with black dots. Make sure to remove the paper labels from the motors before attaching the propellers.

Silver-top propellers tighten clockwise; black-top propellers tighten counterclockwise. Check the lock and unlock icons on each propeller to see the correct directions for tightening and removing.

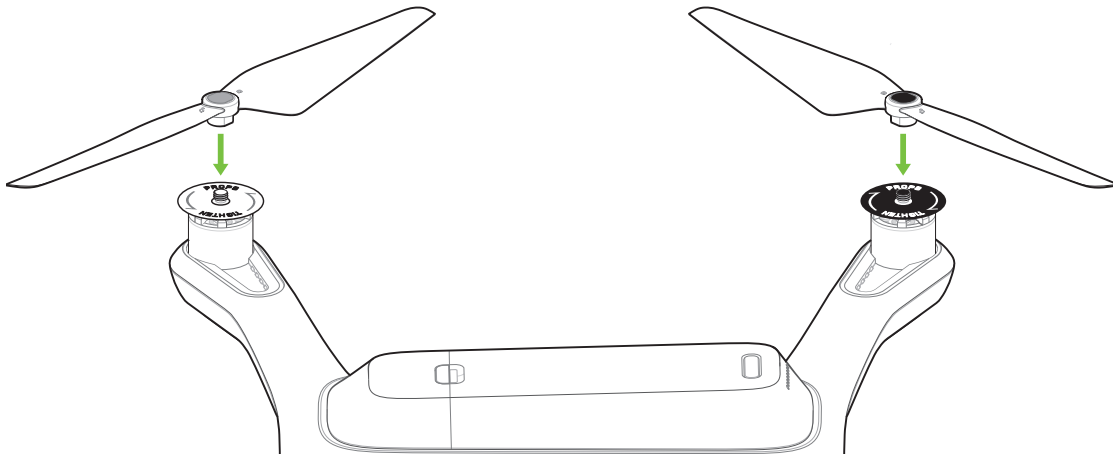

Figure 2.5.1.1: Attach Propellers



## 2.6 Camera

The Solo package includes a fixed GoPro® The Frame™ mount for your GoPro® HERO 3, 3+ or 4.

**Note:** If you have Solo with 3-Axis Gimbal or have installed the Gimbal separately, see Section 3.2.5, Camera Installation, on page 19.

### 2.6.1 Attaching GoPro to The Frame

To attach the camera to the GoPro® The Frame™ fixed mount, insert your GoPro® upside down and connect the Solo HDMI cable to the camera.

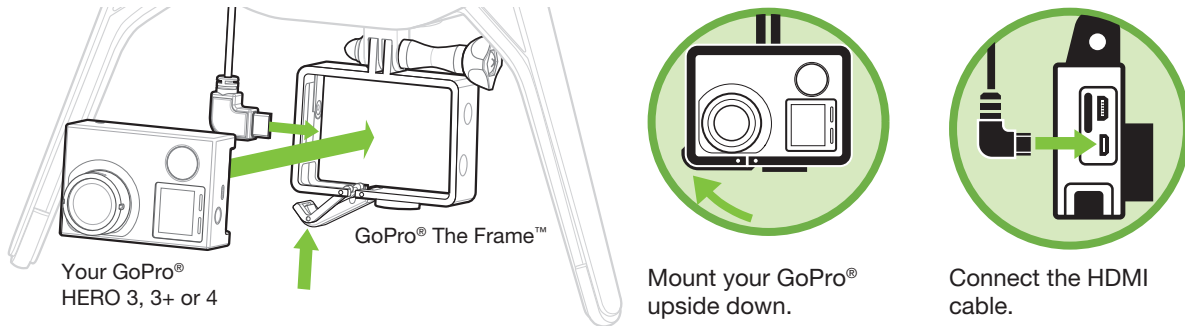

Figure 2.6.1.1: Attach Camera

### 2.6.2 Settings

For best results, adjust the camera settings for inverted orientation and medium field of view. (Setting the field of view to medium ensures that you won't see the propellers in the frame.)

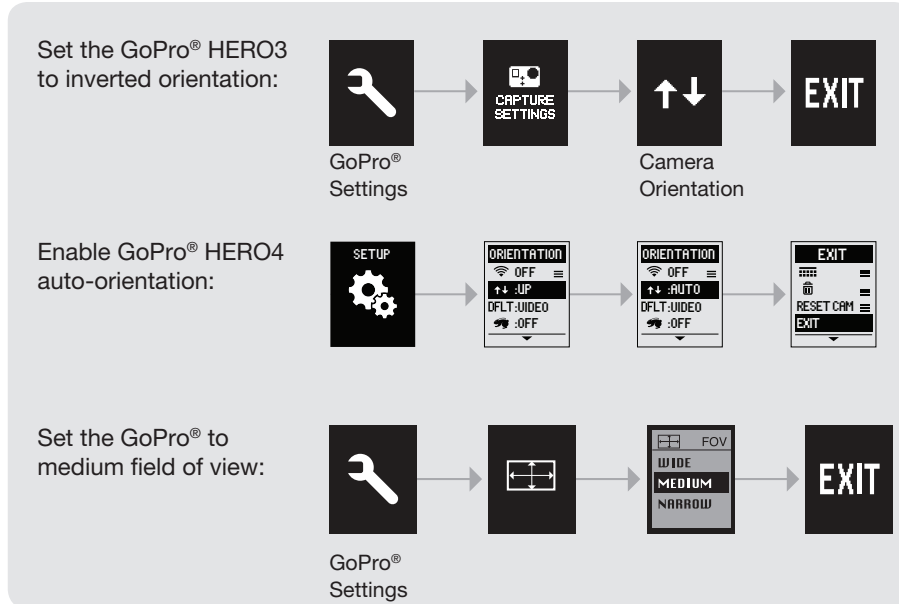

Figure 2.6.2.1: Camera Configuration Process



Make sure the Wi-Fi on your GoPro® is turned OFF. Otherwise, it can interfere with Solo's communication signals and cause unexpected behavior.

## 2.7 Mobile App

The Solo App provides a streaming-video link to a mobile device and a simple graphic interface for using Smart Shots and other advanced Solo features.

### 2.7.1 Install

Visit [3dr.com/soloapp](http://3dr.com/soloapp) or download “3DR Solo” from the App Store or Google Play Store. 3DR Solo works with iOS 8.0 or later and Android 4.3 or later. For Android, you must also install the “3DR Services” app to your device.

### 2.7.2 Register

The first time you run the App, you’re prompted for registration information and the Solo serial number. You also have the option to view some intro videos. Once you’ve completed this process, you’re taken to the home screen of the App.

### 2.7.3 Connect to Solo

To connect the App to Solo’s 3DR Link Wi-Fi network, tap the Connect button on the home page of the App and follow the prompts. When in the Wi-Fi settings on the mobile device, connect to SoloLink\_####. Enter the temporary password “sololink”. Once connected, return to the app to continue. Both Solo and the controller must be powered on to connect to the App.

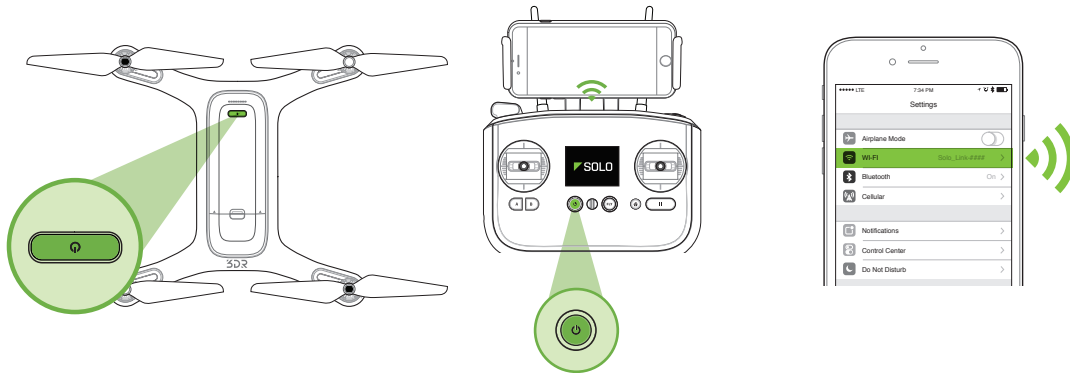

Figure 2.7.3.1: Connect to Solo Link

### 2.7.4 Change SoloLink Password

Once connected to Solo Wi-Fi, change your password to secure your SoloLink network as follows: Access the Settings section by tapping Settings at the bottom-right of the home screen, then choose Solo to access the options for your drone.

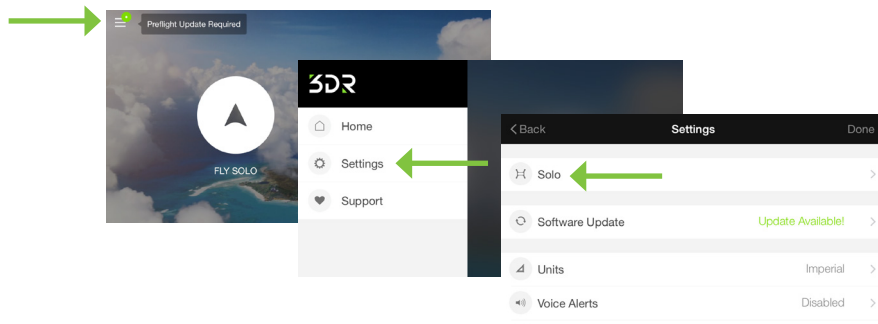

Figure 2.7.4.1: App - Settings Menu

In the Solo section, select Solo Name & Wi-Fi, and set a new password. The password should be between 8 and 32 characters with no spaces. Select Apply to enable your changes. If you forget your SoloLink password, perform the factory reset procedure described in Section 10.7 to reset the password to the temporary password (sololink).

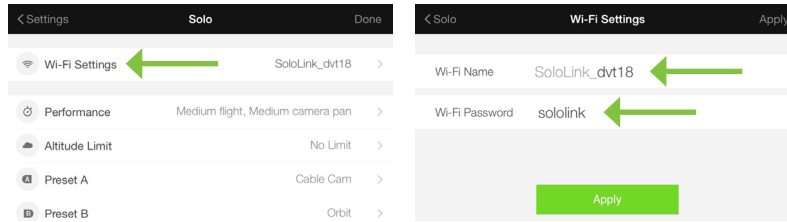

Figure 2.7.4.2: App - Wi-Fi Settings

## 2.7.5 Update

Before your first flight, use the App to perform the required first-flight update of Solo and the Controller. The Controller will prompt you for the update with the preflight update alert. Ensure that both the controller and Solo are powered, the Controller has at least 50% battery remaining, and the app is connected to Solo Wi-Fi. The total update process can take up to 10 minutes.

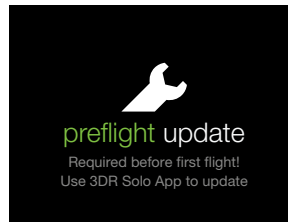

Figure 2.7.5.1: Controller Preflight Update Prompt

To start the update, open the Settings menu in the App, and select Software Update.

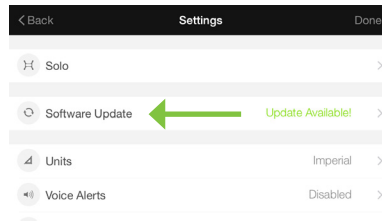

Figure 2.7.5.2: App - Software Update

Because your mobile device has never connected to this Solo before, you will need to link your device with Solo Wi-Fi (SoloLink).



Figure 2.7.5.3: App - Connecting Instructions

Then follow these instructions to connect to Solo Wi-Fi:



Figure 2.7.5.4: App - Instructions List

Once connected, return to the App and you will be notified of the current version you are about to update to. To continue, select Download Update. For this step you will need an Internet connection, either cellular data or Wi-Fi. If you opt to use Wi-Fi, you'll need switch from SoloLink to your Wi-Fi network.



Figure 2.7.5.5: App - Download Update

When the App detects an active connection with the controller, it prompt you to begin the update. (Solo and the controller must be powered on to connect to Solo Wi-Fi.) To start the update, select Begin.

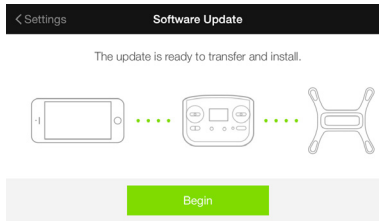

Figure 2.7.5.6: App - Start Update

While the update is in progress, the controller shows the controller updating display. The controller completes a full restart as part of the update process, which can take up to five minutes.

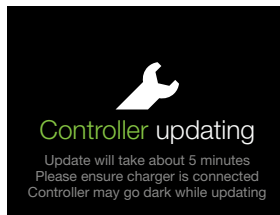

Figure 2.7.5.7: Controller - Updating

Because the Controller must restart as part of the update process, your device will lose its connection to Solo Wi-Fi. When you see the following screen, select Next to continue.

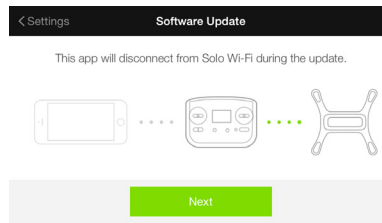

Figure 2.7.5.8: App - Update Disconnection Confirmation

The Controller restarts and displays a green checkmark to indicate its update was successful. When you see the green checkmark on the controller, reconnect to Solo Wi-Fi in the app and press A on the controller to continue the update.

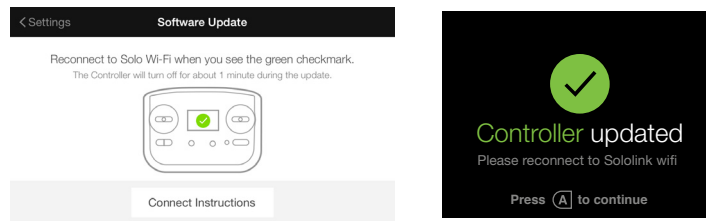

Figure 2.7.5.9: Controller Update Complete Displays

After you press A, Solo restarts to complete the update. While Solo restarts, the controller displays “waiting for Solo.”

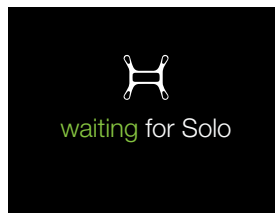

Figure 2.7.5.10: Controller - Waiting for Solo

When the update is complete, Solo’s LEDs turn green, the controller returns to the standard takeoff screen, and the App shows that the software is up to date. After displaying green, Solo’s LEDs return to the standard white-and-red pattern. If you do not see white-and-red LEDs after a few minutes following the update, restart Solo.

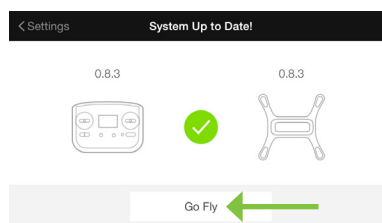

Figure 2.7.5.11: App - Update Success

## 2.7.6 View Video

After the update is complete, to view video in the app, first make sure Solo, the controller, and the GoPro® are powered on, and that the App is connected to Solo via Wi-Fi. Then, on the App home screen, tap Fly Solo.

Before your first flight, verify that you can see video. If the video is inverted, see section 2.6.

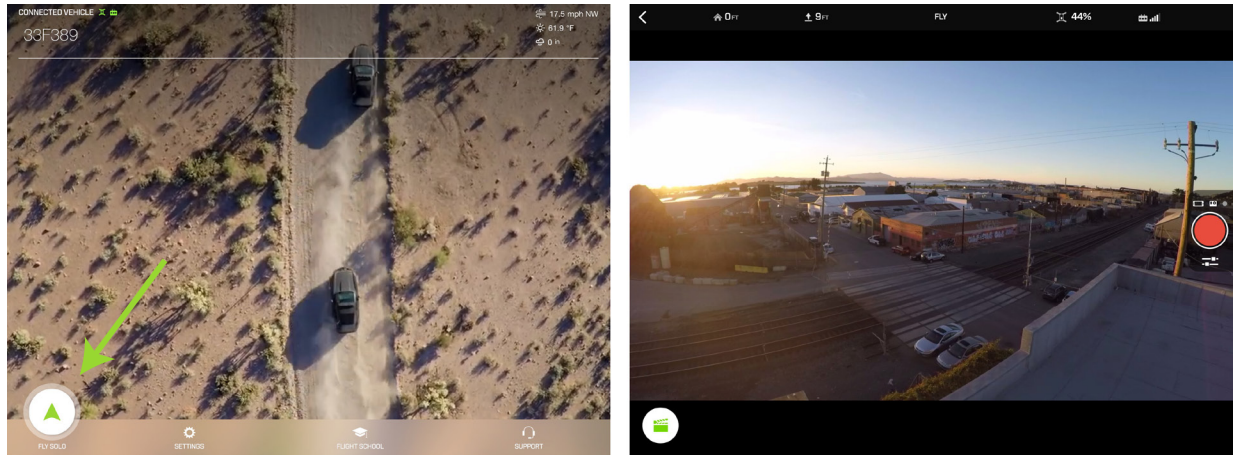

Figure 2.7.6.1: App - Viewing Video

## 3 The Solo Gimbal

The optional Solo Gimbal holds your GoPro® camera and lets you control it remotely. It taps Solo's intelligence to get perfectly automated shots, plus rock-solid footage, GoPro® control and charging, and long-range HD video feed. With the 3-Axis Solo Gimbal, you get:

- Smooth and fluid HD footage every flight.
- Start and stop recording (HERO4 models) while you fly so you can pick and choose the shots you want.
- Footage stabilized to within 0.1 degree of pointing accuracy for enhanced Smart Shots.
- Fine-grain camera tilt control, including angle presets and instant speed adjustment.

**Note:** If you purchased the Solo with 3-Axis Gimbal package, skip to section “Camera Installation” on page 19.

### 3.1 In the Box

The Solo 3-Axis Gimbal package includes the Solo Gimbal, the sunshade, four balance weights for the GoPro® camera, and a screwdriver for installing the Gimbal.

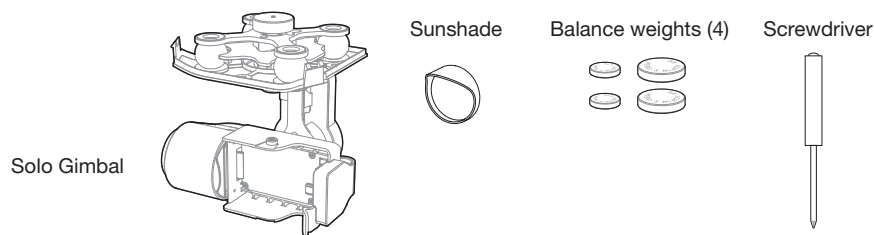

Figure 3.1.1: Solo Gimbal Parts

To install the Solo Gimbal and start utilizing its features, follow these Solo Gimbal installation instructions:

### 3.2 Gimbal Installation

Before installing the Solo Gimbal, make sure the firmware on Solo and your GoPro as well as the Solo App on your mobile device are up to date for the best performance.

Recommended versions:

- Solo: 1.2.0 or higher
- Solo App: 1.2.0 or higher
- GoPro: 3.00.00 or higher

#### 3.2.1 Remove The Frame

1. Flip Solo over to access the bottom of the vehicle.
2. The Frame is secured to Solo by three captive screws (permanently attached to the mount to prevent losing them). Since these screws don't come out all the way, loosen each screw until they can't be backed out any further.
3. Detach the mount from Solo by gently lifting up on it.
4. Route the HDMI cable out through the mount to complete the separation.

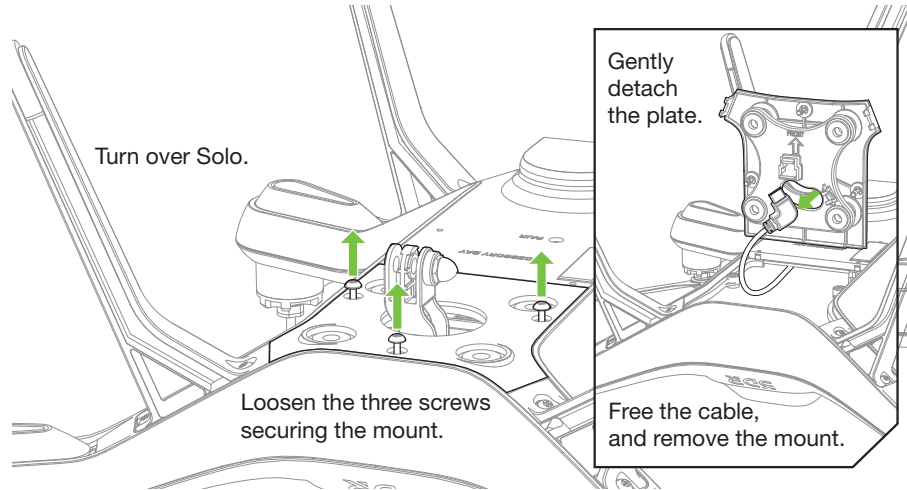

Figure 3.2.1.1: Removing The Frame

### 3.2.2 Connect Gimbal

1. Remove the foam insert holding the gimbal in place and set it to the side (this piece is used to help protect the gimbal during travel).
2. On the bottom of the gimbal plate are two ports: one for the HDMI cable and one for the gimbal cable. Plug in the cables running from Solo to their respective ports on the gimbal, as shown following.

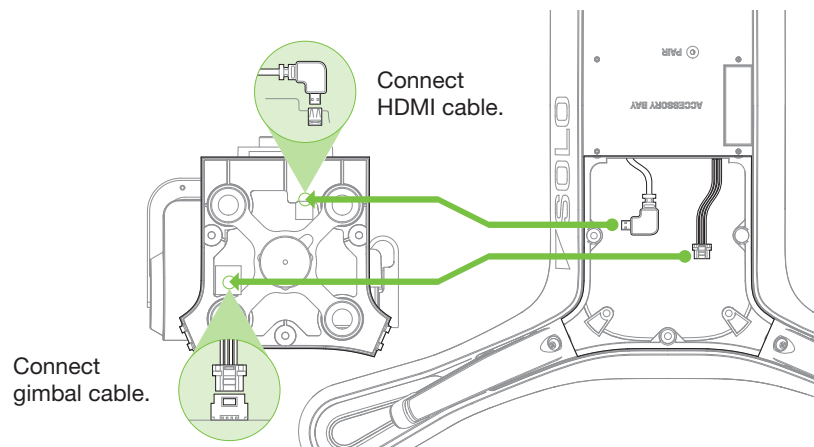

Figure 3.2.2.1: Connecting cables

### 3.2.3 Position Cables

With both cables now connected to the Solo Gimbal, it is important to position each cable out of the way of other internal components. When configuring the HDMI and gimbal cables, the HDMI cable should rest on top of the gimbal cable.

1. Position the gimbal cable out of the way by pushing any slack towards the front of the Solo Shell.



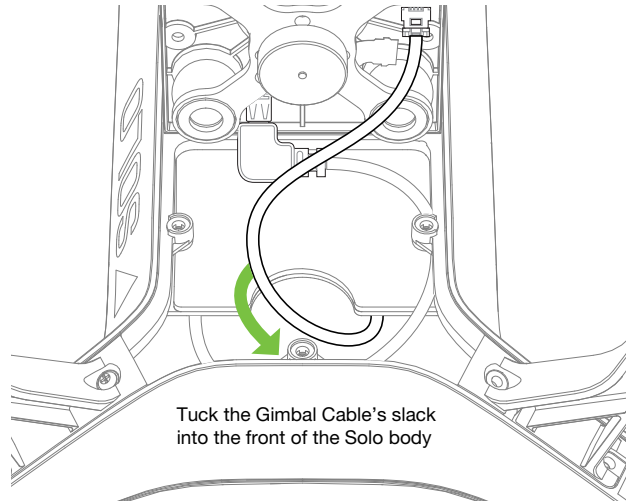

Figure 3.2.3.1: Positioning the Gimbal Cable

2. Loop the HDMI cable around and inside the front of the body, pushing any extra slack towards the pocket of Arm #01 as seen below.

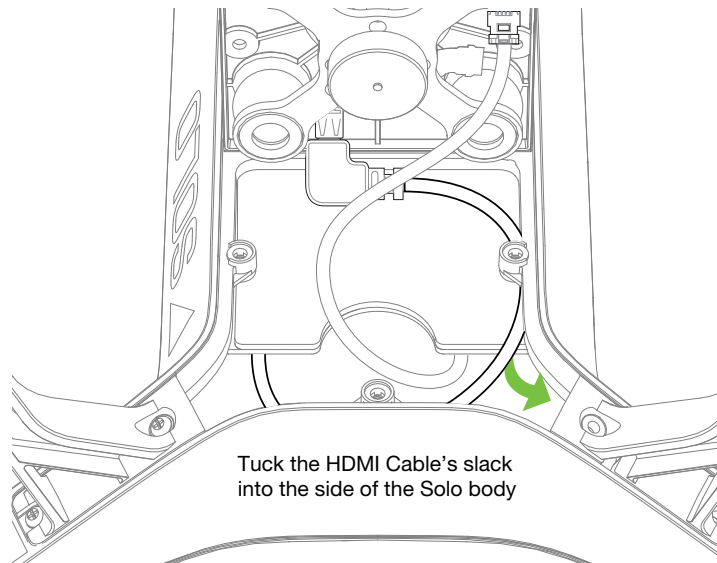

Figure 3.2.3.2: Positioning the HDMI Cable

### 3.2.4 Mount the Gimbal

1. Position the gimbal plate over the opening in the Solo Shell, making sure that the three screw positions are aligned (two in the back and one in front).
2. Slide the back of the plate in first, and then pinch the two front prongs in and down to insert the plate.

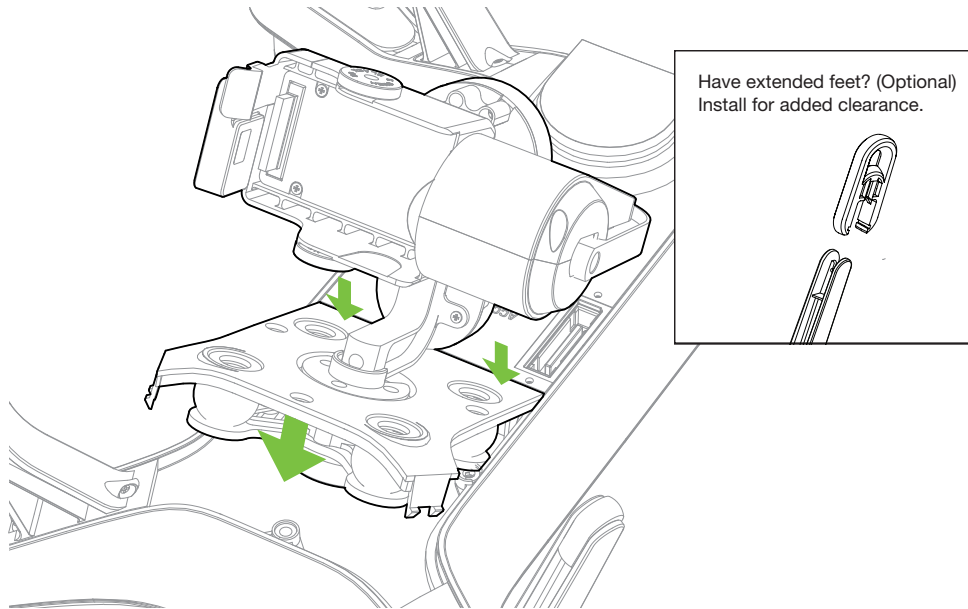

Figure 3.2.4.1: Mounting the Gimbal

3. When the plate is inserted and resting flush with the Solo Shell, tighten each of the three captive screws.

If the plate isn't resting flush with the Solo Shell, the most likely cause is that the screws didn't catch correctly. If the screws are misaligned, do not try to tighten them. Back out any crooked screws with the screwdriver, then realign them manually before tightening with the screwdriver.

### 3.2.5 Camera Installation

The 3-Axis Solo Gimbal holds your GoPro® HERO 3, 3+ or 4. To install your GoPro camera, follow these directions:

1. To create space for your GoPro inside the camera housing, move the the rubber HDMI plug out and away from the camera housing.

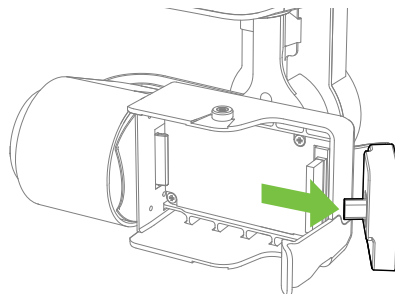

Figure 3.2.5.1: HDMI Plug Positioning

2. Slide your GoPro into place from the front and gently press it in until it is flush with the back of the camera housing.

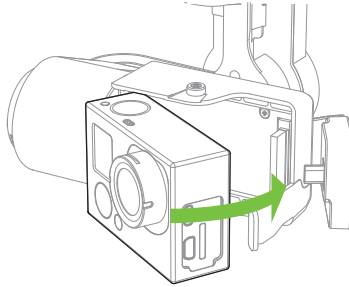

Figure 3.2.5.2: Attach GoPro

3. Take the rubber HDMI plug and insert into the exposed side of your GoPro. This simultaneously fastens the GoPro into place and secures the HDMI connection. Your GoPro is now installed!

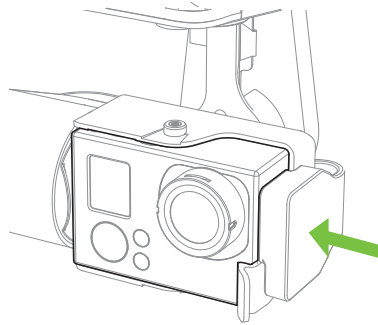

Figure 3.2.5.3: Fasten Camera

### 3.2.6 Add Balance Weights

Out of the box, the Solo Gimbal is perfectly weighted for use with the GoPro HERO4 Black. If you are using the GoPro HERO4 Silver or the GoPro HERO3+, then you need to add balance weights to optimize these cameras for use with the Solo Gimbal. To balance your GoPro, attach the corresponding balance weights to the threaded inserts on the top and bottom of the camera housing, as shown following.

GoPro Weight Balancing <sup>®</sup>	
HERO4 Black	No balance weights needed
HERO4 Silver	Add the 2.7g balance weights
HERO3+ Silver	Add the 6g balance weights

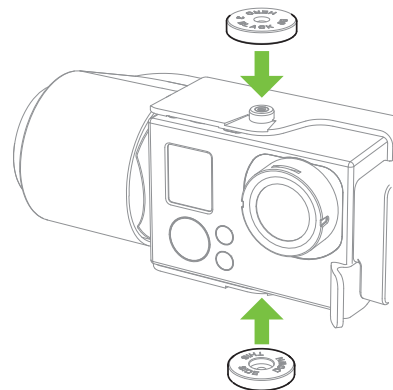

Figure 3.2.6.1: GoPro Weight Balancing

### 3.2.7 Add Sunshade

Flying on a sunny day? Use the sunshade to protect your video from glare. Simply press-fit the sunshade onto the GoPro lens to install.

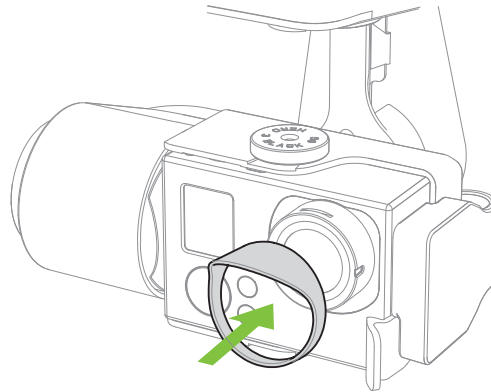

Figure 3.2.7.1: Adding the Sunshade

### 3.2.8 Update Your GoPro

The GoPro HERO4 Silver and HERO4 Black are fully optimized to work with the Solo Gimbal. To use functions like Start Recording and Stop Recording, your GoPro HERO4 must be fully up to date. You can update your GoPro in either of two ways: Update through an iOS or Android mobile device, or through your computer.

#### Option 1: Download the Update Using your iOS or Android Device

1. Make sure you have the GoPro App downloaded onto your iOS or Android device, and that you have an SD card with plenty of available memory installed in your GoPro.
2. On the GoPro camera, go to Setup and then Wireless. Choose the Pair/Connect option, then GoPro App, and then follow the directions.
3. Open the GoPro app.
4. Connect your camera.
5. When you get to the screen with the live video preview, tap the downloads button at the top of the screen. It's a circle with an arrow in the middle.
6. Follow the prompts to download and install the update.
7. Before flying, make sure the GoPro's Wi-Fi is off! Hold the button on the side.

#### Option 2: Download the Update Using Your Computer

1. On your computer, navigate to 'gopro.com/update'.
2. Choose your camera model from the list on the left.
3. Select "Update Your Camera Manually".
4. Follow the instructions to register and update your GoPro.

### 3.2.9 Recommended GoPro Settings

For optimal results, adjust your camera settings to these recommended values. If you're using the Solo Gimbal with the GoPro Hero3+ Black or either Hero4 model (Silver or Black), you can change settings in flight: For details, see Section 6.1.3, Camera Controls and Settings, on page 40.

Resolution	1080P or 2.7K
Field of View	Medium
Low Light	Off
Spot Meter	Off
Protune	On (if available)
White balance	Auto
Color	GOPRO
ISO	400
Sharpness	Medium
EV Comp	0

Figure 3.2.9.1: Camera Configuration Process



Make sure that the Wi-Fi on your GoPro® is turned OFF. Otherwise, it can interfere with Solo's communication signals and cause unexpected behavior.

## 3.3 Gimbal Operation

The Solo Gimbal is a nearly autonomous tool. For example, it handles camera balancing and stabilization for you automatically. However, we recommend that you be aware of some operational aspects of the Solo Gimbal, as well as a handful of controls you can use.

### 3.3.1 Controlling the Solo Gimbal

To manually adjust the tilt angle of the Solo Gimbal, use the tilt control paddle to move the gimbal up and down. You can also set up an automatic tilt control using the '1' and '2' button presets. These buttons are located above and below the tilt speed dial, as shown in Figure 3.3.1.1. To tilt to a preset angle, simply press either button and use the dial to adjust the tilt speed. To save a new preset angle, hold '1' or '2'.

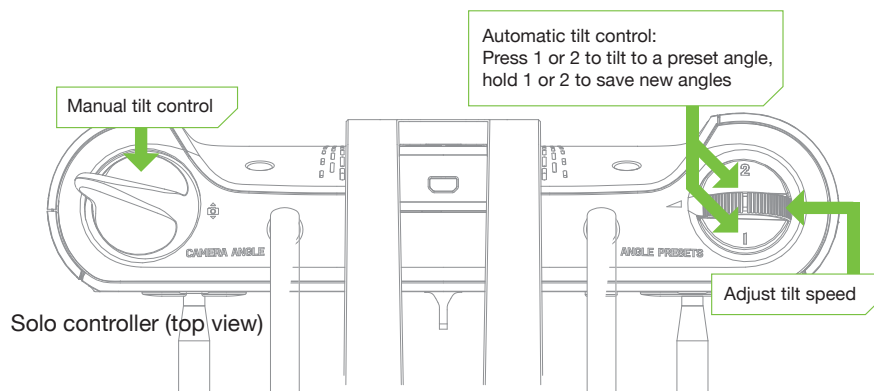

Figure 3.3.1.1: Gimbal Controls

### 3.3.2 LED Signals

On the back of the Solo Gimbal is an LED that signals different status modes of the gimbal.

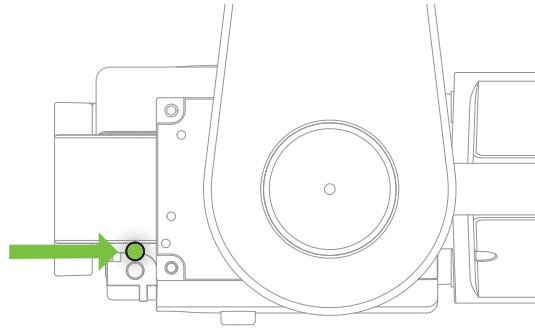

Figure 3.3.2.1: LED Gimbal Signal

The Gimbal LED displays several different signals:

- **Breathing green:** the gimbal is functioning properly and ready for use.
- **Blinking orange:** the gimbal is booting up (commonly seen while performing an update).
- **Blinking blue:** the gimbal has lost the communication signal. Please contact customer support.
- **Breathing red:** the gimbal is in a temporary fault mode. Restart the gimbal, and if the issue persists, please contact customer support.
- **Solid red:** the gimbal is in an unrecoverable fault mode. Restart the gimbal, and if the issue persists, please contact customer support.

### 3.3.3 Troubleshooting

If the Solo Gimbal is not working properly, follow the steps below to troubleshoot the problem:

#### 3.3.3.1 The gimbal is not centered with respect to Solo

- **Symptoms:** The gimbal angle seems cockeyed or the beauty plate (at the top of the gimbal) does not mount flush with the Solo bottom surface.
- **Reason:** Improper cable routing can cause the gimbal to be off-center. This also hurts gimbal performance because of interference on dampers.
- **Resolution:** Make sure the HDMI cable is coiled from left to right in the big radius following the contour of the Solo. The Gimbal Data cable can interfere, make sure the Gimbal Data cable is unwound and is not twisted. For details, go to <https://3drobotics.com/kb/gimbal-installation/>.

#### 3.3.3.2 Frozen GoPro

- **Symptoms:** GoPro doesn't respond to a button press, either on the camera (physical button) or in the Solo App.
- **Reason:** GoPro firmware is not up to date.
- **Resolution:** Your GoPro model must be Hero 3+ or higher. If so, follow these steps:
  1. Remove the GoPro from the gimbal.
  2. Remove the battery from the GoPro.
  3. Wait 20 seconds.
  4. Replace the battery.
  5. Power on the GoPro. At this point, make sure the GoPro firmware is the latest version.

### 3.3.3.3 The gimbal is not turning on or responding

- **Symptoms:** Gimbal appears not to be receiving power.
- **Reason:** Possible connectivity issues.
- **Resolution:** Check the LED on the gimbal (behind the GoPro) and refer to the color guide in Section 3.3.2. If the LED is off, make sure the gimbal connector is plugged in and seated properly.

If none of the preceding steps resolved your gimbal issue, please contact customer support at [3dr.com/support](https://3dr.com/support).

## 4 Safety

The following best practices will help ensure safe, successful flights and help reduce the risk of accident and serious injury:

- Always fly under adult supervision and with your full attention at all times.
- Do not fly under the influence of drugs or alcohol or when your ability to operate Solo safely is impaired.
- Use common sense to avoid unsafe situations and always operate Solo responsibly.



Read and understand these important safety instructions before your first flight to help reduce the risk of accident and serious injury.

### 4.1 Location

When choosing an appropriate place to fly Solo, keep these location factors in mind:

- Don't fly Solo indoors.
- Always fly outside in clear, open areas at a safe distance from yourself, other people, power lines, animals, vehicles, trees, and buildings.
- When flying in areas with potential hazards, maintain a distance of at least 100 feet (30 m) from any people, vehicles, or structures. As the operator, you are responsible for navigating Solo to avoid obstacles, including during Smart Shots.
- Don't fly within five miles of an airport or within any airspace restricted by your local, state, or national airspace authority. As the operator, you are responsible for knowing and understanding the regulations that govern small, unmanned aircraft like Solo in your jurisdiction.

### 4.2 Environmental Awareness

Don't fly Solo in extreme weather conditions such as rain, high winds, snow, or fog. Such weather conditions can permanently damage Solo or cause instability in flight.

Before flying, determine the boundaries of the safe flying area at your location. Be aware of any risks, including bodies of water, structures, trees, power lines, etc, and designate a few areas where you can land Solo in case of an unsafe situation. Throughout your flight, be prepared to recover Solo manually or use an emergency procedure if Solo flies outside the safe flying area.

### 4.3 Visual Line of Sight

Always fly Solo within your visual line of sight. Don't let Solo get so far away from you that you cannot see its orientation or so that any physical obstructions block your view of Solo.



Physical obstructions can also block communication signals with the controller, causing Solo to attempt to Return Home along an obstructed path



## 4.4 Flight School

If you're new to flying, review the video tutorials in the Flight School area of the App before your first flight (make sure your device is connected to the Internet). Flight School provides useful tips for learning to operate Solo safely and correctly.

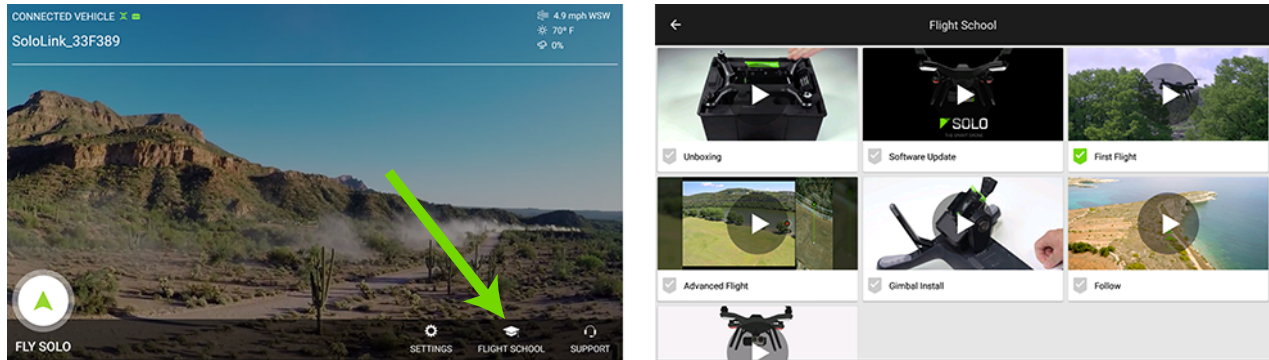

Figure 4.4.1: App Flight School

## 4.5 Propellers



**Spinning propellers can cause serious injury.** Never touch moving propellers or place any objects in the way of the propeller arcs while Solo is powered.



To avoid hazardous contact with Solo's high-speed propellers, always power off Solo before handling Solo or the propellers. When prompted to start motors before takeoff, always ensure that the propellers are clear of any obstructions and at least 20 feet away from any people, animals, or property before activating. Do not touch moving propellers or approach Solo while the propellers are spinning.

After landing or returning home, Solo automatically detects the landing and stops the motors. Do not approach Solo until the propellers stop spinning, and always power off Solo before picking it up.

## 4.6 GPS

Solo requires an active GPS signal for flight. After powering on, Solo can take up to five minutes to acquire a strong GPS lock. Always choose a flying location with a clear view of the sky to improve GPS signal strength. The following requirements define a GPS lock:

- Reported horizontal position accuracy < 16 ft. (5 m)
- Reported speed accuracy < 2 mph (1 m/s)
- Number of satellites  $\geq 6$
- Difference between GPS and inertial navigation vertical velocity < 2 mph (1 m/s)

If satellite coverage drops beneath a reliable threshold during flight, Solo will automatically switch to Fly:Manual mode. This mode does not provide the flight-stabilizing GPS functionality, but it still lets you control Solo.

## 4.7 Home Position

Solo's home position is the latitude and longitude coordinates of the launch point and is used by the autopilot as the end point of a return-home command. The autopilot saves the home position location to where the motors are started, assuming GPS lock has been achieved. If Solo has taken off without GPS lock and then achieves GPS lock mid-flight, the home position will be set to wherever GPS lock was acquired. The location of the home position depends on GPS signal strength and is usually within one to two meters of accuracy. Always take off from an open location with a clear path for Solo to return home safely. For home position safety in advanced mode, see Section 8.4.

## 4.8 Altitude Limit

Always fly at appropriate altitudes for your flying location and local regulations. Solo cannot avoid obstacles on its own, so always select altitudes that avoid any obstacles, such as trees, buildings, and power lines.

Solo includes a safety fence enabled by default at 150 ft. (46 m). If Solo reaches the altitude limit, it stops ascending and limits throttle input to stay below the altitude limit. To adjust the altitude limit, see Section 8.7. FAA regulations mandate a maximum altitude of 400 ft. to avoid potential conflicts with manned aircraft and represents a safe line-of-sight altitude.

## 4.9 Emergency Procedures

If you experience a problem in flight, use one of the following emergency procedures to stop Solo, end your flight, or shut off the motors.

### 4.9.1 Pause

The controller's Pause button allows you to stop Solo in mid-air. Solo hovers at the paused location until given another command. Use the Pause button to stop Solo from hitting an obstacle or to reorient Solo for navigation. During Return Home or Land, you can pause Solo and stop the landing by pressing Pause. Pause is available only with GPS lock.

### 4.9.2 Regain Manual Control

Keep the controller easily accessible at all times during flight, including during Smart Shots, and be prepared to regain manual control at any time. To return to standard flight during Smart Shots, Return Home, or Land, press the Fly button.

### 4.9.3 Return Home

If Solo acquired GPS lock prior to takeoff, you can return it to the launch point and land by pressing Return Home on the controller. If you receive a low-battery notification or want to quickly end your flight, press Return Home. Solo does not avoid obstacles while returning home; always verify that the return path is clear before activating Return Home.

### 4.9.4 Land

To land Solo at its current position, press and hold the Fly button. To exit the landing procedure at any time, lift the throttle. If Solo does not have GPS lock, automatic positioning is not available as Solo descends, and drifting can occur depending on environmental conditions.

### 4.9.5 Motor Shutoff

In the event that Solo's motors do not stop after landing or for an emergency in-flight kill switch, Solo includes an emergency motor shutoff procedure. To shut off the motors at any time, either in flight or on the ground, hold the A, B, and Pause buttons at the same time. An initial screen will appear on the controller to confirm the shutoff command; continue to hold A, B, and Pause buttons to activate motor shutoff. Use the emergency motor shutoff only as a last resort.

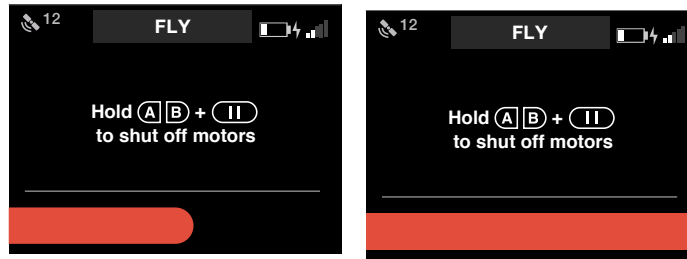

Figure 4.9.5.1: Controller - Motor Shutoff

## 4.10 Flight Battery

Use caution when handling the Solo Smart Battery; lithium polymer batteries can cause a fire if handled incorrectly. Never alter, puncture, throw, bend, or impact the battery. Keep the battery away from liquids, fire, microwaves, and other hazardous or combustible materials. Don't expose the battery to extreme temperatures. If the battery is hot to the touch, wait for it to cool before using or charging.

Inspect the battery before and after each flight. It is possible for the battery to be damaged in shipping, use or charging. If you notice any abnormal features such as damage to the exterior shell, swelling, deformation of the battery, abnormal smell, leakage, or other unexpected behavior, do not use the battery! These can be signs of serious damage that can cause the battery to catch fire. To prevent a hazard in case of fire or explosion, disconnect the battery, and place the battery in a safe area outside of any buildings or vehicles and away from flammable materials. Do not dispose of the battery in the trash; bring it to a battery recycling center as soon as possible. In the US and Canada, visit [call2recycle.org](http://call2recycle.org) to find a location.

For long-term storage, store the battery in an 64° F (18° C) to 82° (28° C) F environment, between 45-85% relative humidity and with 50% charge. Always store the battery in a place where it won't be exposed to extreme temperatures or direct sunlight.

## 4.11 Controller

The controller's rechargeable lithium ion (Li-ion) battery is housed inside the controller, accessible by the battery door on the back of the controller. The controller battery is pre-attached to the controller, and shouldn't be disconnected unless:

- You plan to store the controller for over three months without using it. In this case, disconnect the battery from the controller and leave the battery inside the controller to store it.
- You need to replace or upgrade the controller battery. Upgraded controller batteries with double the capacity are available from [store.3dr.com](http://store.3dr.com) or an authorized retailer. In the case where you need to store the extra controller battery, store it in a location where it will not come into contact with metal objects or other batteries. If the battery's connector comes into contact with a metal object, it can short circuit the battery and cause a fire.

Keep the controller away from liquids, fire, microwaves, and other hazardous or combustible materials. Don't expose the controller to extreme temperatures. If the controller is hot to the touch, wait for it to cool before using or charging. Perform periodic visual inspections of the controller battery to check for any damage, and handle the controller battery using the same safety precautions as the flight battery.

## 4.12 Antenna Configuration

For the strongest connection to Solo, position the antennas down and away from the controller so they are approximately perpendicular to Solo in flight, and tilt each antenna out and away from one another at a 20° angle.

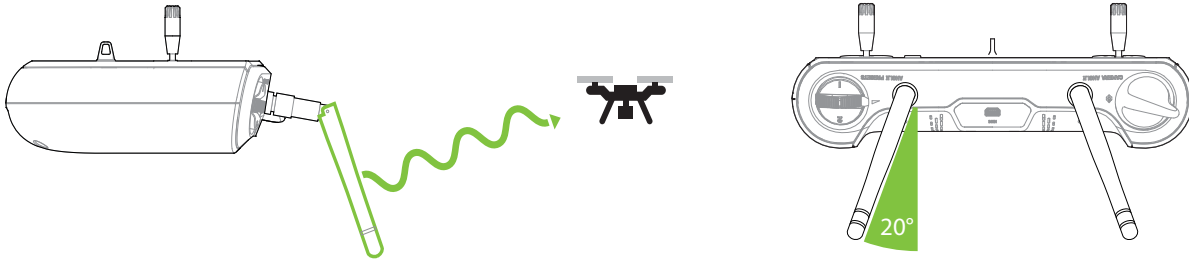

Figure 4.12.1: Controller Antenna Orientation

## 5 First Flight

This section covers basic Solo flight procedures, including takeoff, landing, and manual control.

### 5.1 Preflight Checklist

Before flying, check the following conditions:

#### 5.1.1 Location

- » Your current location and environmental conditions are suitable for flight. (Section 4.1)
- » Solo is on a level surface at a clear launch point a sufficient distance from yourself and others. (Section 4.1)

#### 5.1.2 Components

- » The propellers are correctly attached. (Section 2.4)
- » The propellers can spin smoothly and without obstruction when turned.
- » No components on Solo appear loose or damaged.

#### 5.1.3 Power

- » The controller is powered on with at least 50% charge. (Section 2.3)
- » Solo is powered on with a fully charged battery. (Section 2.2)

#### 5.1.4 Video (Optional)

- » The Solo app is connected to Solo and streaming video. (Section 2.6)
- » The GoPro® is recording. If have the Solo Gimbal and the GoPro HERO4, you can start and stop recording mid-flight. You can also change camera settings in flight while not recording.

## 5.2 Takeoff

The takeoff process has two steps: start the motors, then take off. Always place Solo at a clear launch point for takeoff, at least 20 feet away from you, other people, and structures.



Flying close to obstacles like buildings and trees can reduce GPS accuracy and might result in unexpected flight behavior.

#### 5.2.1 Activating Motors

When Solo is ready to fly, the controller will prompt you to hold the Fly button to start Solo's motors. Hold Fly until the propellers spin. Solo is now active, ready for takeoff, and needs to be treated with appropriate caution to avoid safety hazards. To stop the motors, press the Pause button any time Solo is on the ground with the motors spinning.

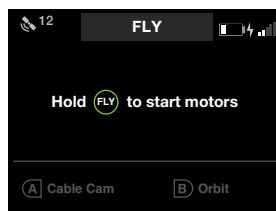

Figure 5.2.1.1: Controller - Start Motors Prompt



**Spinning propellers can cause serious injury!** Always make sure Solo is clear of any obstructions and all people and animals are away from Solo before spinning the props.



## 5.2.2 Initiating Takeoff

Hold Fly again to initiate takeoff. Solo will rise to 10 feet (3 m) and hover until it receives further control inputs.

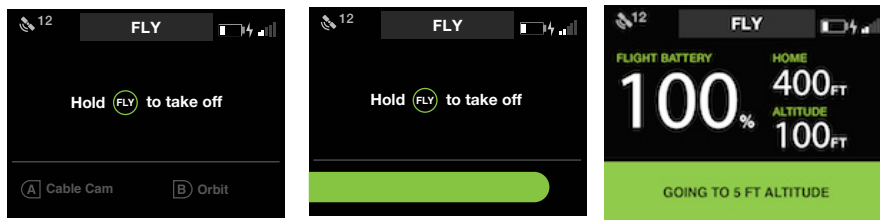

Figure 5.2.2.1: Controller - Takeoff Prompts



Be aware of Solo's orientation before takeoff so you can safely navigate Solo up and away from you once it's in the air. If Solo is facing towards you at takeoff, move the right stick back; if Solo is facing away from you, move the right stick forward.

## 5.3 Landing

To land Solo at its current location, hold the Fly button.



Figure 5.3.1: Controller - User-Initiated Landing



When you command Solo to land, it will land at the current location, wherever it is. Always make sure there is a clear path to a safe landing point directly below Solo before landing.

After landing, the propellers will stop spinning automatically; wait until the propellers stop spinning before approaching Solo. If the propellers do not stop, press the controller's Pause button or use the emergency shutoff option described in Section 4.9.5.



Never approach Solo while the propellers are spinning. After an auto-landing or return-to-home, always wait until the propellers stop before approaching or touching Solo.

## 5.4 Return Home

The Return Home function brings your flight to an end by recalling Solo to its launch location and landing. You can initiate Return Home manually by pressing the Return Home button on the Controller. Alternatively, in certain circumstances, Solo initiates Return home autonomously; for details, see Section 7.2, In-Flight Errors, on page 61.

Keep in mind that Return Home requires enough battery charge to get back to the launch point. If you need to end your flight immediately, land manually or hold the Fly button. Return Home requires GPS lock prior to takeoff.

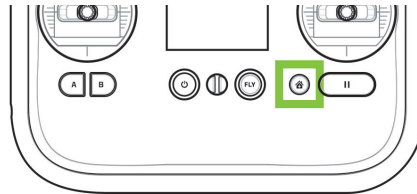

Figure 5.4.1: Return Home Button



Always verify that there is a clear path to the home point before activating Return Home.

### 5.4.1 Smart Return Home Functionality

When a call to Return Home is triggered, it is critical that Solo make a swift and safe journey back to the Home Position. Among the factors involved in balancing these priorities are:

- The farther away Solo is, the greater the likelihood that it could encounter unforeseen obstacles (buildings, trees, etc.). Because of this, longer-distance scenarios benefit from climbing in altitude before traversing back home.
- The closer Solo is to the Home Position, measured laterally, the more confident we can be that there are fewer obstacles in the return path, and thus the safer it would be for Solo just to land.

To help eliminate unnecessary ascents in favor of more efficient return flights, we developed the “Cone Zone.”

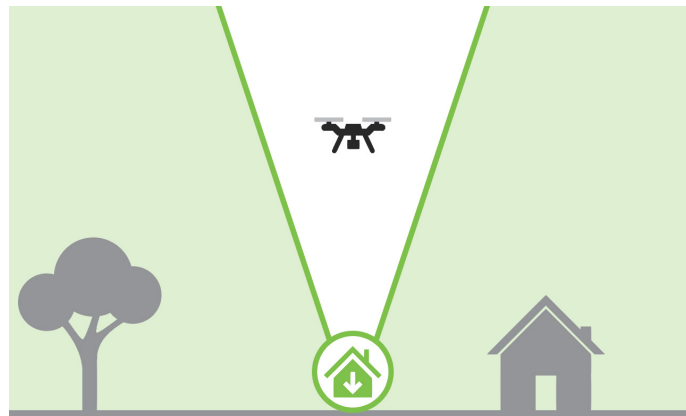

Figure 5.4.1.1: The Cone Zone

The Cone Zone represents the volume that is least likely to be filled with problematic obstacles. The shape of this cone is based on a 1:3 ratio of horizontal distance to altitude. So as your altitude increases, so does the cross-sectional area of the cone. Once Solo reaches the boundaries of the cone or is already within the cone, then its main priority is to traverse to directly over the Home Position and land.

### 5.4.2 Obstacle-Free Cone Zone

The following examples walk you through the different flight scenarios and how the Cone Zone affects the Return Home behavior in each scenario.

#### Case #1: Above the Return Home Altitude

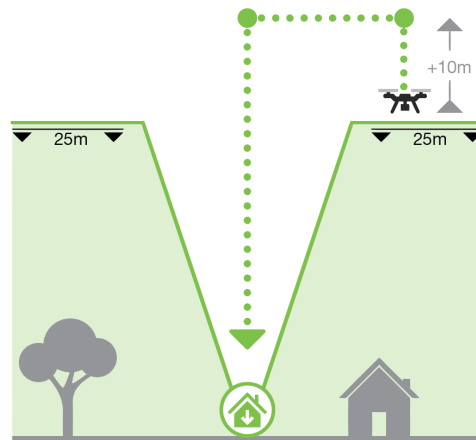

Figure 5.4.2.1: Above Return Home

When a call to Return Home is triggered and Solo is flying above the Return Home Altitude (default: 25m), Solo:

1. Climbs 10m
2. Traverses to the Home Position
3. Descends and lands

#### Case #2: Within the Cone

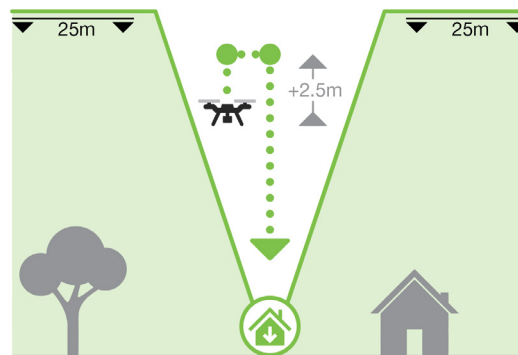

Figure 5.4.2.2: Within the Cone

When Solo is inside the cone and Return Home is triggered, Solo:

1. Climbs 2.5m
2. Traverses to the Home Position
3. Descends and lands



### Case #3: Below the Return Home Altitude and Outside the Cone

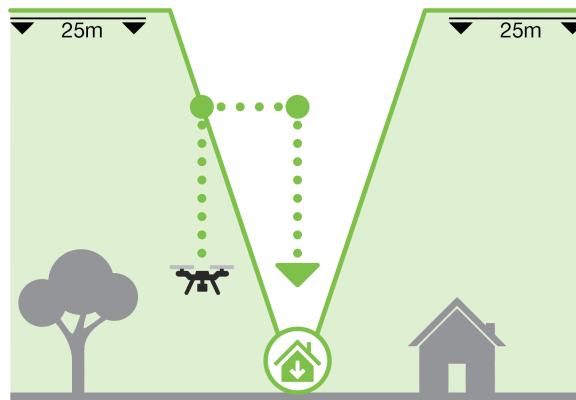

Figure 5.4.2.3: Below Return Home and Outside the Cone

The radius of the Cone Zone expands at a 1:3 ratio of lateral distance to altitude. This means that the Cone radius is directly related to the Return Home altitude. As Solo's altitude increases, so does the radius of the cone. If Solo's lateral distance from the Home Position exceeds this ratio, it is then outside the cone. In the occurrence of a call to Return Home, Solo:

1. Either climbs to the boundary of the cone or to the Return Home Altitude, whichever happens first
2. Moves to the Home Position
3. Descends and lands

## 5.5 In-Flight Data

Use the controller's main data display to monitor Solo's status in flight.

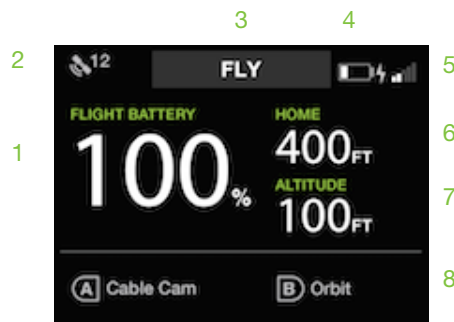

Figure 5.5.1: Controller - In-Flight Data

- 1 Flight battery percentage remaining
- 2 GPS signal strength and number of active satellites
- 3 Active mode or Smart Shot ("Fly" indicates standard flight.)
- 4 Controller battery level
- 5 Solo Wi-Fi signal strength
- 6 Horizontal distance from the home position (launch point)
- 7 Current altitude
- 8 Currently assigned functions of controller A and B buttons

## 5.6 Joystick Control

The controller's two joysticks allow you to navigate Solo in flight. The left stick controls Solo's altitude and rotation.

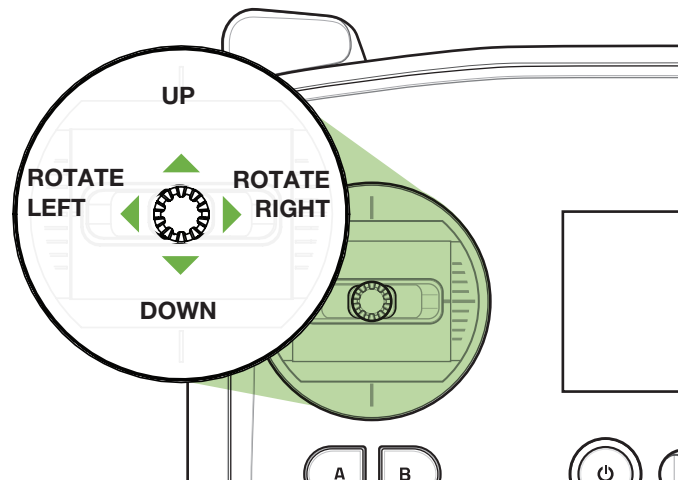

Figure 5.6.1: Controller Left Joystick

To control Solo's altitude and acceleration, move the left stick vertically.

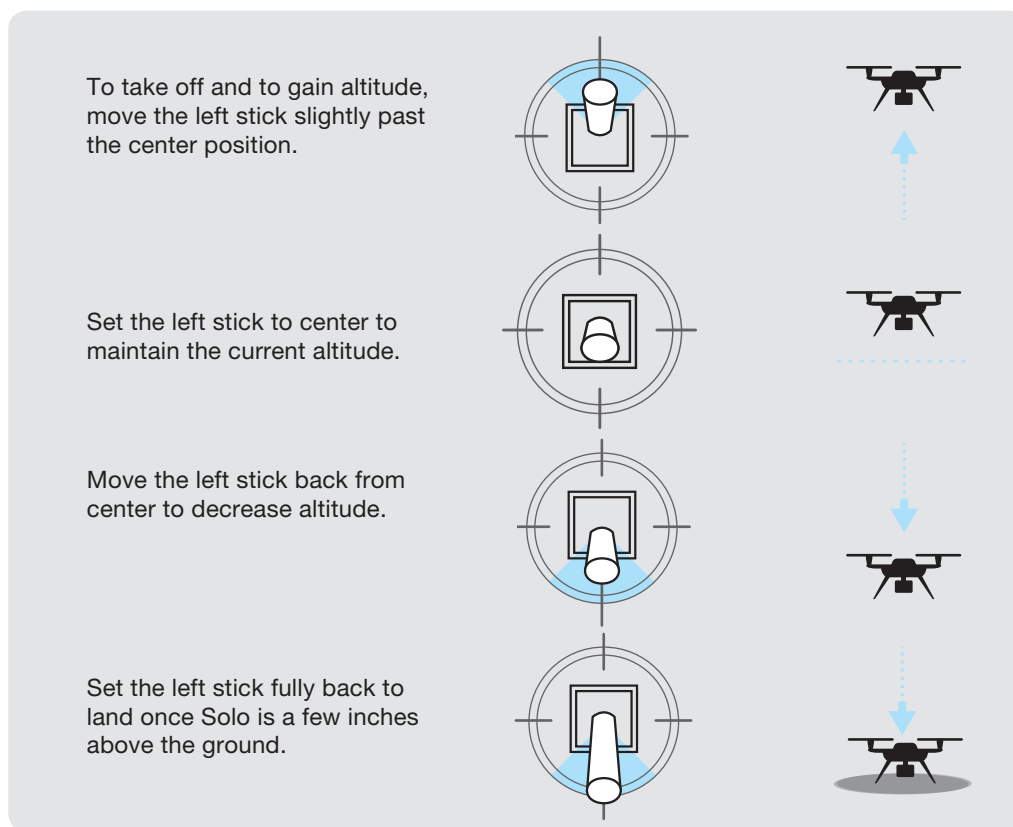

Figure 5.6.2: Throttle Joystick Behaviors

To rotate Solo and control orientation, move the left stick horizontally.

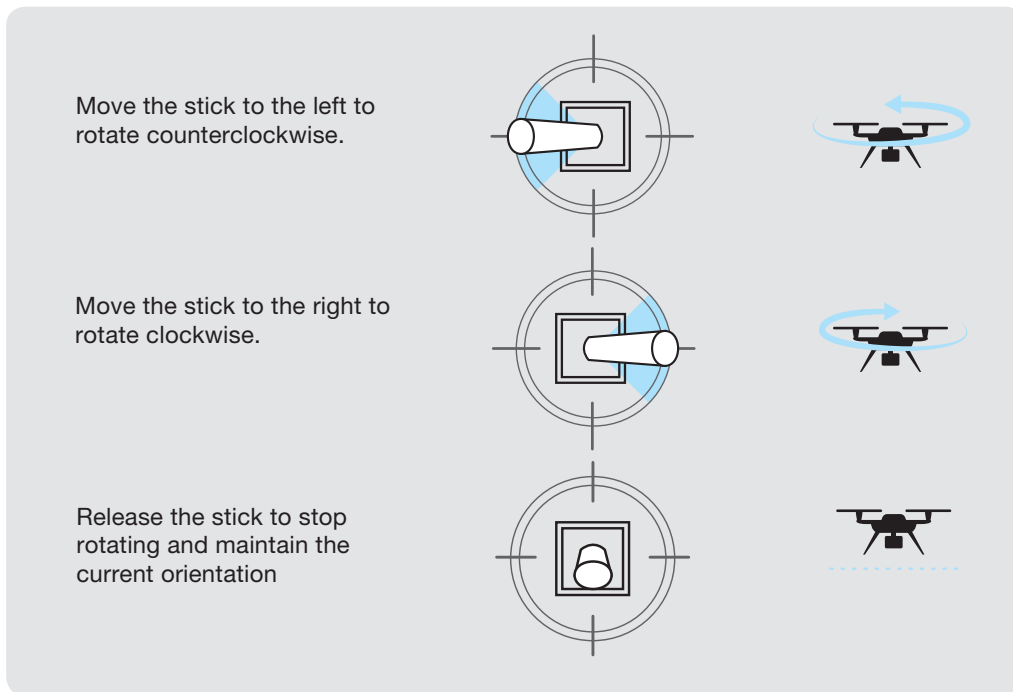

Figure 5.6.3: Yaw Joystick Behavior

Use the right stick to fly Solo forward, back, left, and right. These movements are relative to Solo's current orientation, so always maintain awareness of Solo's forward-facing direction before using right-stick controls.

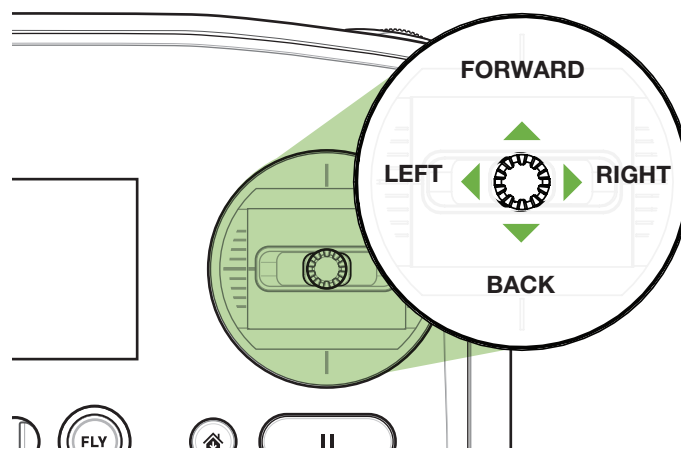

Figure 5.6.4: Controller Right Joystick Controls

To control pitch, move the right stick vertically.

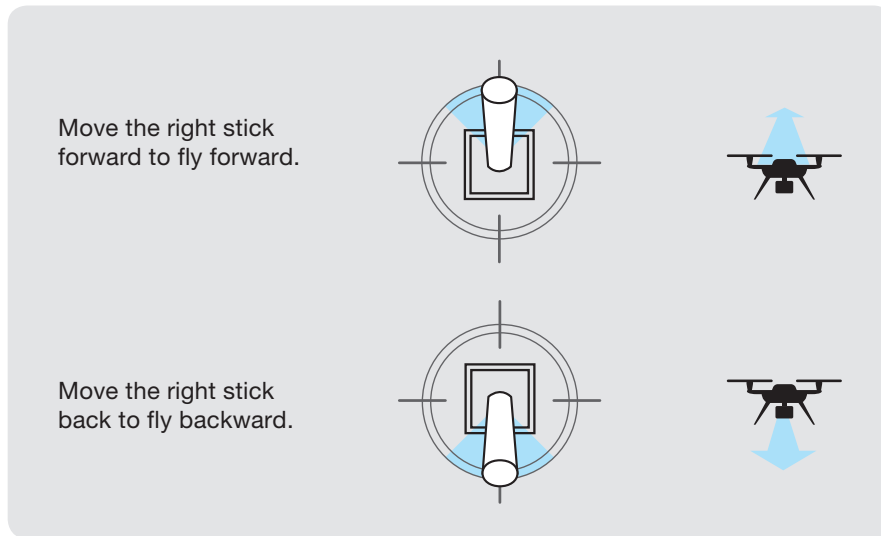

Figure 5.6.5: Pitch Joystick Controls

To control roll, move the right stick horizontally.

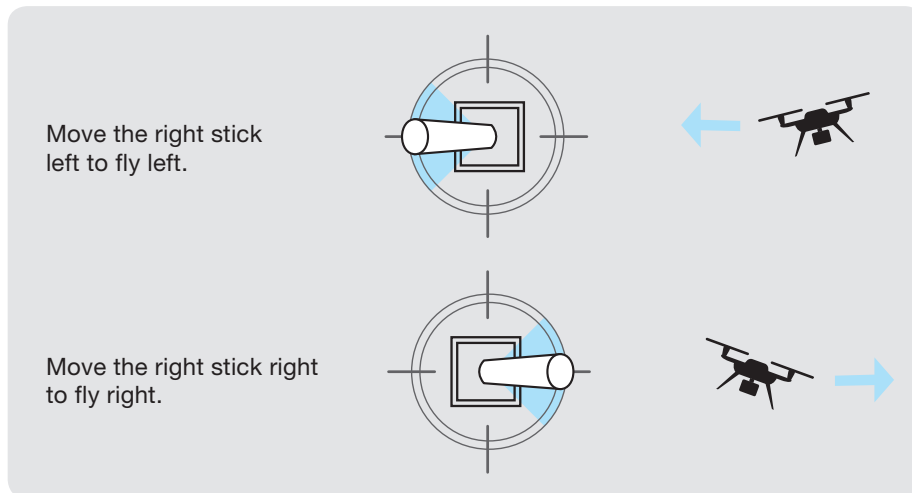

Figure 5.6.6: Roll Joystick Controls



If you're new to drones, take some time to learn the basics before your first flight. Visit [3dr.com/solo/info](https://3dr.com/solo/info) or check out Flight School in the Solo app to learn about flight controls and best practices.

## 6 Using the Solo App

### 6.1 App Interface Overview

The Solo App provides a simplified interface for viewing Solo's video feed and managing Smart Shots. The first screen in the App is the home screen:

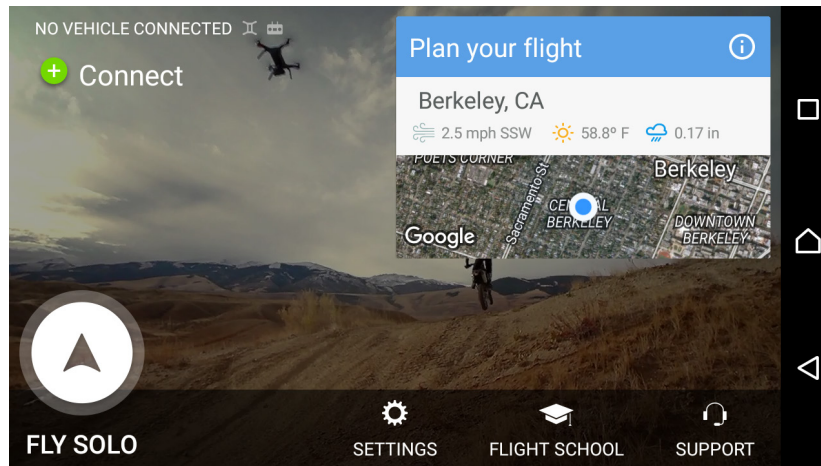

Figure 6.1.1: Solo App Home Screen

The primary function here is to go to the main screen by tapping Fly Solo on the left side of the screen. Also, if you're not connected to Solo and are using the Android version of the App, a Connect button appears in the top-left corner; you can connect to Solo by tapping the Connect button and following the directions. The iOS version of the app displays a Connection Instructions button instead.

Before you start flying, it's important to become familiar with your environment. The Plan Your Flight overlay shows your current location and weather conditions. For more information about this feature, see the section immediately following this one.

Additional controls at the bottom of the App home screen are as follows:

- **Settings:** Go to the section of the app where you can change settings for Solo, the Controller, and the App. You can also update the software and firmware from here.
- **Flight School:** Takes you to a listing of instructional videos for getting started with Solo. To view the videos, your device must be connected to the Internet.
- **Support:** Provides resources for solving problems, logging support tickets, and related issues.

Also, the home screen might display a notice: Software Update Available. This indicates that updated firmware is available for Solo, the Controller or both. The update typically features improved performance and new features. To get the update, simply tap the notice and follow the directions.

#### 6.1.1 Plan Your Flight

When you start the Solo App, or whenever you're on the home screen, a rectangular, three-layer overlay in the top-right corner provides several types of information (see preceding illustration):

- At the top of the overlay is the message "Plan your flight." To access this part of the App, tap the banner at the top of the overlay (see following).  
**Note:** This message can vary based on current flying conditions.
- The second layer of the overlay provides mission-related information: the current location (city, town, etc.), wind speed and direction, outdoor temperature, and current rainfall.  
**Tip:** You can change how this information displays with the Metric/Imperial switch in Settings > Units.
- The bottom layer shows a miniature map of your current location.

When you tap the overlay, the App opens a map of your current location:

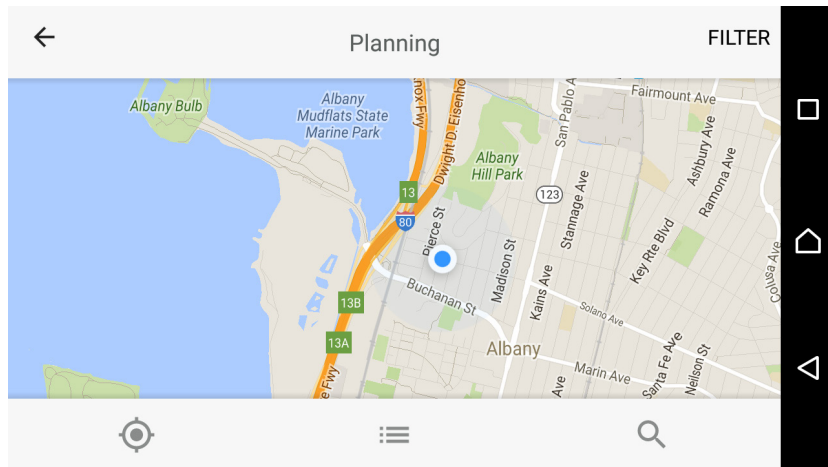

Figure 6.1.1.1: App - Plan your flight screen

The blue dot in the center shows your position on the map. You can scroll, zoom, and rotate the map with standard touchscreen gestures. Typically, to see areas that are off limits for flying drones, zoom out:

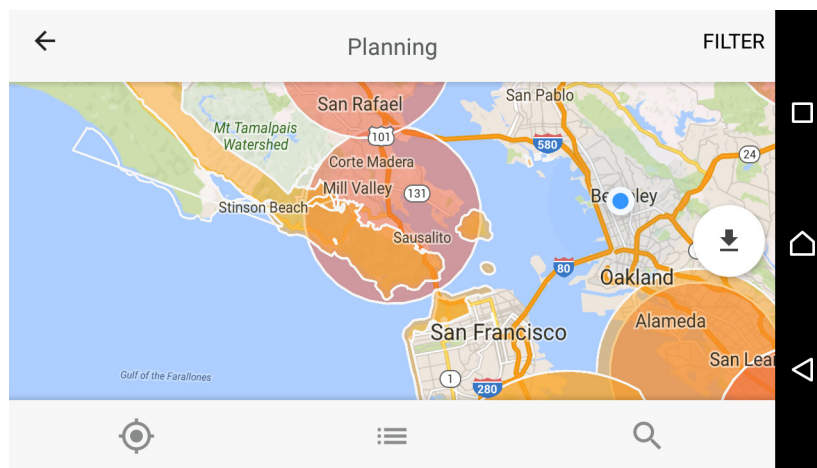

Figure 6.1.1.2: App - Planning map zoomed out

Proscribed areas are marked with colored circles, as the preceding illustration shows. To get further information on a proscribed area, tap its circle to open a descriptive panel:

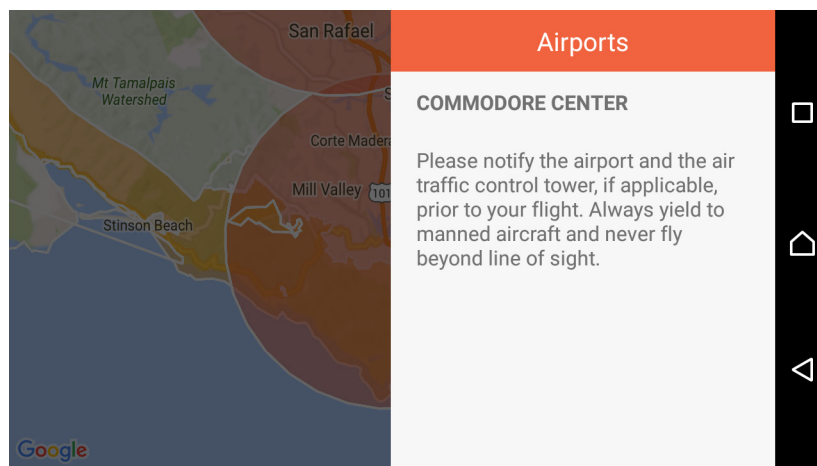





Figure 6.1.1.3: App - Proscribed area description

Below the map are three icon buttons:

-  Centers the map on your current location.
-  Opens a list of locations where flying drones is prohibited, categorized by filter (see following illustration). Tap an item to see its location on the map.
-  Opens a search dialog. Enter a search term to get a list of matching locations in your area, then tap a result to see its location on the map.

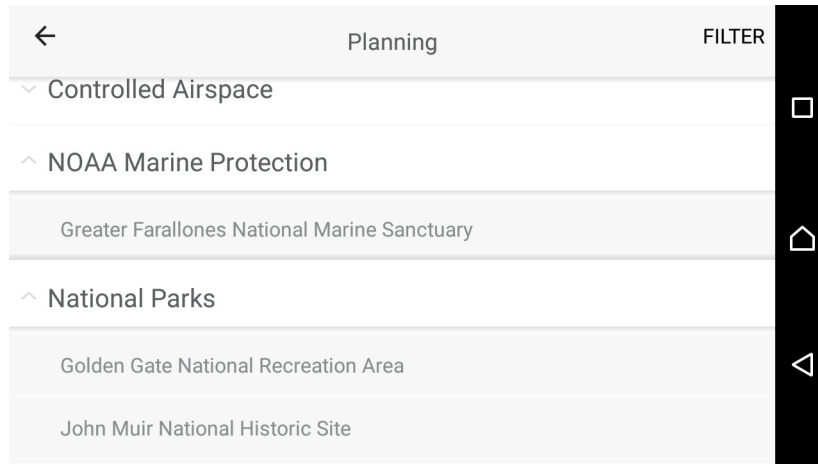

Figure 6.1.1.4: App - List of proscribed locations

To change the type of flight-related information the map displays, tap FILTER at the top right. This opens a list of categories of proscribed areas that you can turn on and off to customize the display, as well as options for the overall map display:

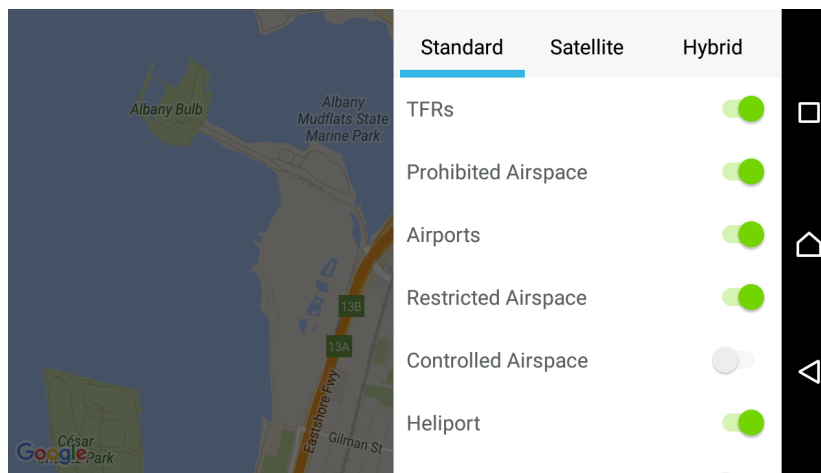

Figure 6.1.1.5: App - Filters

The map-display options are:

- **Standard:** A typical two-dimensional map showing the names of major thoroughfares and locations
- **Satellite:** The map uses satellite photographs for greater realism
- **Hybrid:** A combination of Standard and Satellite styles

The FILTER options, which generally show you where flying is prohibited, are:

- **TFRs (Temporary Flight Restrictions):** A TFR is a geographically limited, short-term airspace restriction. Temporary flight restrictions often encompass major sporting events, natural disaster areas, air shows, space launches, and presidential movements.

- Prohibited Airspace
- Airports
- Restricted Airspace
- Controlled Airspace
- Heliport
- Infrastructure: Includes buildings around which pilots need to exercise caution, including structures such as schools, hospitals, and bridges.
- National Parks
- NOAA Marine Protection: Includes areas along the U.S. coastline that are sanctuaries for wildlife and should be avoided.



## 6.1.2 Main Interface

This is the screen you'll use most of the time when flying Solo. It's available by tapping Fly Solo on the home screen. The main screen provides the live video feed from the GoPro camera, telemetry statistics, access to Smart Shots and the map view, and more.

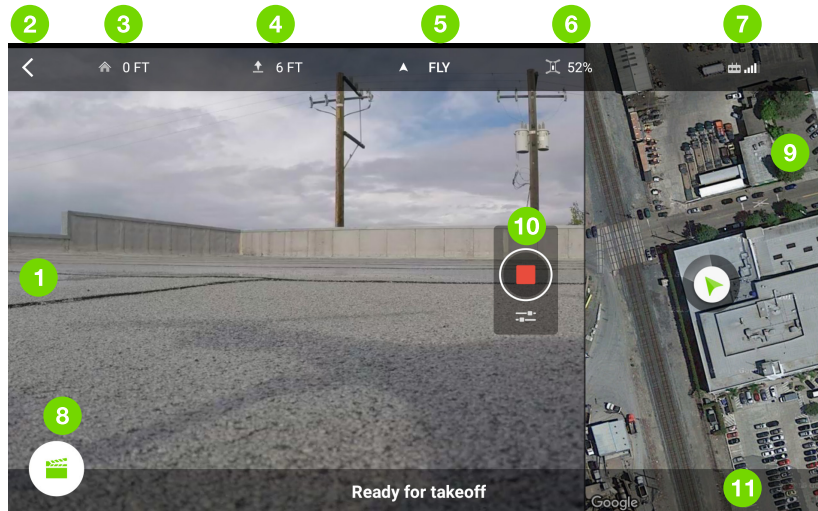

Figure 6.1.2.1: App - Main Interface

1. Live video feed: Shows video from the camera mounted on Solo.
2. Go to home screen: Returns to app start.
3. Horizontal distance from launch point: Solo's distance from the starting point, disregarding height.
4. Altitude: Solo's vertical distance from starting point.
5. Current flight mode: Fly by default, or active Smart Shot.
6. Solo battery percentage remaining: Also visible on Controller screen.
7. Controller signal strength
8. Shot List: Access to Smart Shots.
9. Map view (see following for details)
10. Camera controls (see Section 6.1.4 for details)
11. Alerts and instructions

To toggle advanced telemetry data, tap any of the telemetry readouts at the top of the screen: item 3, 4, 6, or 7. The additional information appears as follows:

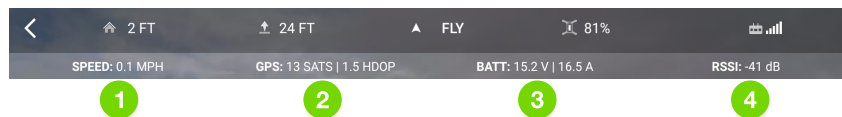

Figure 6.1.2.2: Advanced telemetry data

1. Solo's current air speed
2. Number of satellites and HDOP
3. Solo battery voltage and amperage
4. Wi-fi signal strength between Solo and Controller

### 6.1.3 Map View

To access the small map view, swipe left a short distance from the right edge of the app. To full-screen the map, swipe left again. To hide the small map, swipe to the right. To return from the full-screen map, tap the picture-in-picture video display at the top-left of the map.

A live map view is normally available only with GPS lock and on devices with mobile data (cellular Internet).

With a Wi-Fi only iOS device, you can cache map data automatically by connecting to the Internet, then opening the map in the Solo App and navigating to the area you want to map. Then, when you connect the device to Solo, the App automatically remembers the map.

**Note:** iOS controls the map-data cache procedurally; 3DR cannot guarantee its availability. For best results, make sure your iOS device has a reasonable amount of free storage.

If you're using an Android Wi-Fi-only device such as a tablet, with a bit of preparation, you can cache a map section and call it up as needed even if mobile data is not available. You need not be connected to Solo to follow these steps:

1. Connect your Android device to Internet-enabled Wi-Fi.
2. Open the Solo App and tap Fly Solo. This takes you to the main screen, which informs you that Solo is not connected.
3. Position your finger at the right side of the screen and swipe all the way left. This takes you to the map screen, which should resemble the following illustration after loading map data:

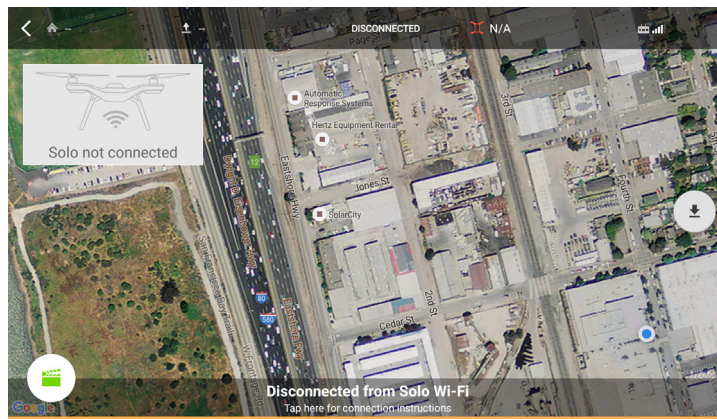

Figure 6.1.3.1: Initial Map Screen

4. To begin the caching process, tap the Download button (⬇️) at the right-center of the screen.

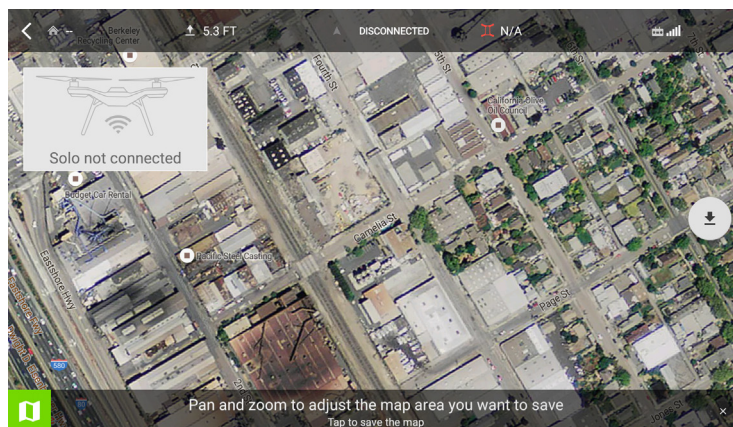

Figure 6.1.3.2: Map Screen During Caching

**Important:** If you do not see the Download button, you can enable it by going to Solo App home screen > Settings > Map Tile Provider and choosing Map Box.

5. Use standard touch-screen gestures to find the map area to cache (that is, the area you're planning to fly in), then, to save the map, tap the "Pan and zoom ..." message at the bottom of the screen. During caching, a progress bar appears, and then the message "Map area saved!" appears shortly above the "Disconnected ..." message.
6. Proceed to the mapped area with your Solo, start flying, and access the map as usual. If the map is full-screen, and you have a live video feed, the video appears in the picture-in-picture (PiP) rectangle near the top-left corner of the screen. To return to the main flying screen, tap the PiP rectangle (whether or not it's displaying video).

#### 6.1.4 Camera Controls and Settings

The Record button on right side of the main App screen lets you start and stop recording with the GoPro camera (3-Axis Gimbal only). When Video Mode is active the button is red, and when Photo Mode is active it's white. When recording video, the red circle changes to a smaller square and the small "LED" icon above the button pulses red. To stop recording, tap the square button.

The area just above the button contains status icons. From left to right, these are Camera Roll (recording video to the mobile device), GoPro (recording video to the camera), and video-recording status.

Below the button is a sliders icon that provides access to camera settings. The following illustration shows different states of the record button and associated icons:

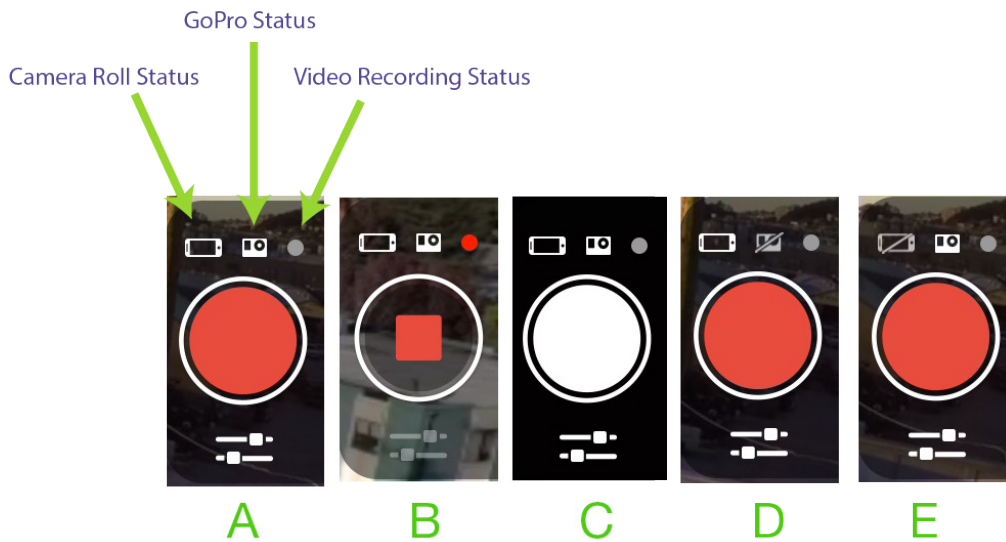

Figure 6.1.4.1: Camera button states

- A: Video mode, not recording
- B: Video mode, recording (note camera settings disabled)
- C: Photo mode
- D: Video mode, GoPro recording disabled (camera might be off or missing memory card)
- E: Video mode, Camera Roll recording disabled by Camera Settings control

To access the camera settings, tap the sliders icon immediately below the record button:

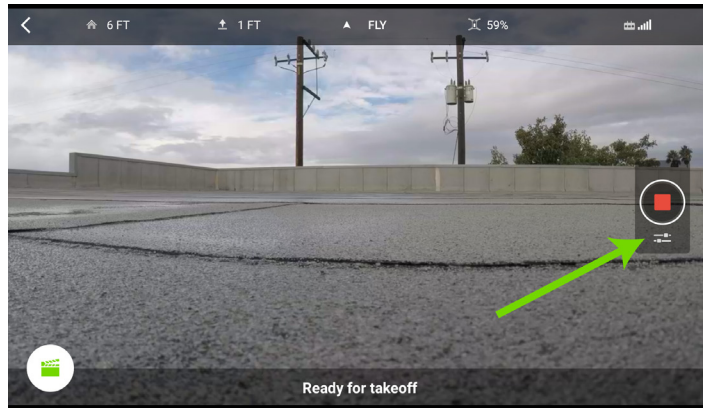

Figure 6.1.4.2: Tap for Camera Settings

**Tip:** You can change camera settings while flying as long as you're not recording.

The two camera-settings areas, available from the buttons on the right side of the screen, are Camera Mode and Camera Settings:

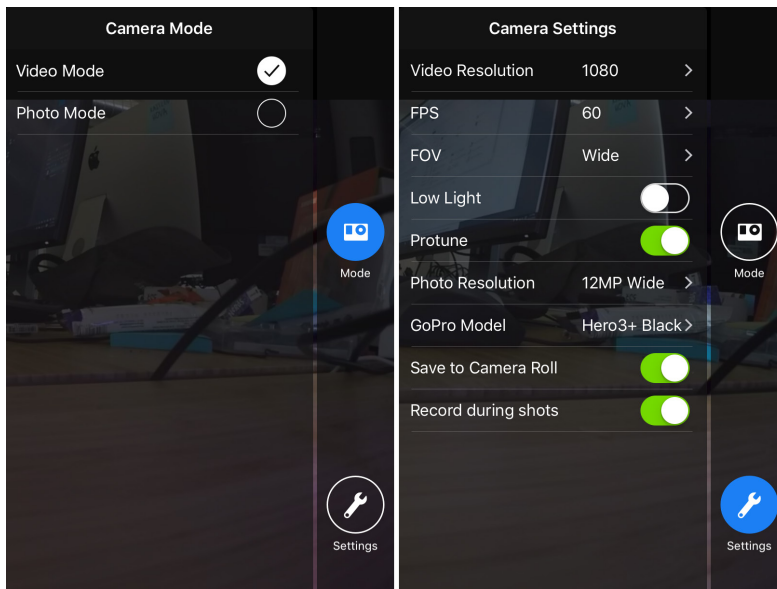

Figure 6.1.4.3: In-App Camera Settings

- **Camera Mode:** Determines what happens when you tap the Record button on the main App screen. Choose Video Mode for recording continuous video; choose Photo Mode for shooting stills.
- **Camera Settings:** Provides access to the following parameters. The available values for each parameter vary depending on the GoPro model and other current parameter values. For details, consult your GoPro manual. For recommended values, see the table in Section 3.2.9, Recommended GoPro Settings, on page 22.

**Note:** All of these settings apply to Video Mode only, except for Photo Resolution, which applies to Photo Mode only.

- **Video Resolution** (in pixels): The resolution the camera uses to capture video. To set still-image resolution, use the Photo Resolution setting instead.

- **FPS:** Frames per second.
- **FOV:** Field of View
- **Low Light:** On or off
- **Protune:** On or off
- **Photo Resolution:** The resolution the camera uses to capture still images in Photo mode.
- **GoPro Model:** Choose the model of GoPro camera you're using. This setting determines the available parameter values.
- **Save to Camera Roll:** When on and recording video to the camera, the mobile device also records the video received by the app from Solo to its internal memory.

The Camera Roll video is available via the same methods as video recorded directly with the mobile device. For instance, if using an iOS device, you can access the Camera Roll video from the Photos app.

- **Record during shots:** GoPro automatically records video whenever a Smart Shot is active.

To exit the camera settings, tap "Done" or anywhere to the left of the settings area.

## 6.2 Smart Shots

Solo's four different Smart Shots automate flying Solo to make it easy to get stunning aerial video. By default, Cable Cam and Orbit are assigned to the controller's A and B buttons. Use the app to access Selfie or Follow. Smart Shots are available only with the Solo app.

**Tip:** When using Smart Shots without a Solo Gimbal, Solo cannot ensure that the subject is in the frame at all times. If this is the case, you can improve the chances of keeping the subject in the frame by adjusting the camera mount so the camera is fixed at an appropriate angle.

To access the shot list, tap the Shot List button (📁) on the main App screen:

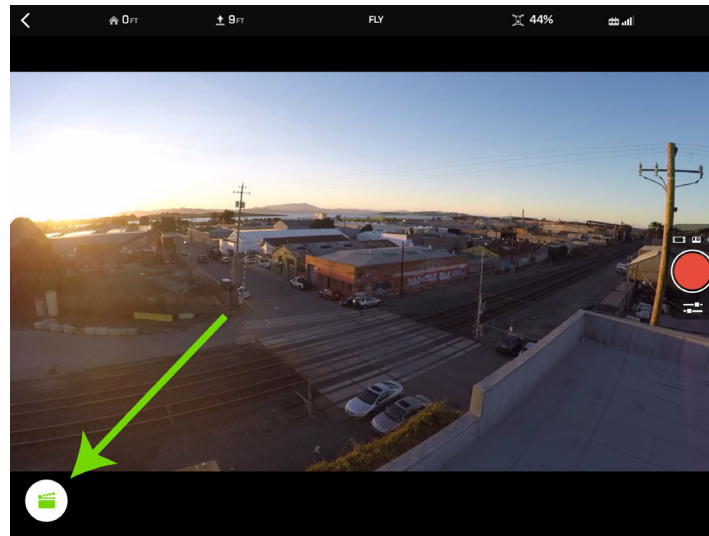

Figure 6.1: App - Main Screen

Then, on the next screen, tap the icon for the Smart Shot you want to use:

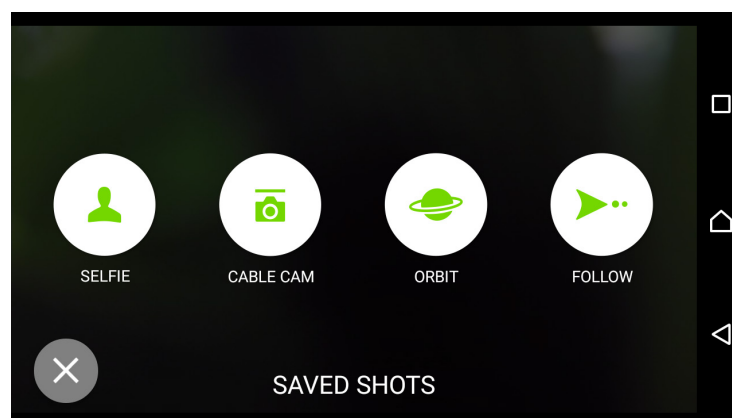

Figure 6.2: App - Shot List

**Tip:** To see directions for a Smart Shot, tap its icon while Solo is on the ground.

## 6.3 Selfie

In Selfie, Solo flies a smooth up-and-back path to capture a subject in a cinematic establishing shot. Before starting a Selfie shot, always ensure that there is a clear path 200 feet (61 m) behind and above Solo. Once you activate Selfie mode, Solo flies up and away from the subject to a point 164 feet (50 m) from the subject at 82 feet (25 m) altitude. You can change these default distances with Selfie Options.



Figure 6.3.1: Selfie Path and Settings

- 1 Distance away (default 164 ft.)
- 2 Altitude up (default 82 ft.)
- 3 Flight path



Always ensure that there is a clear path 200 feet (30 m) behind and above Solo before starting Selfie. Press To stop Solo at any time, press Pause. To switch to manual control at any point, press Fly.

### 6.3.1 Selfie Setup

To start Selfie, fly Solo to a starting point, facing the subject from approximately 10 feet away, and select Selfie from the Shot List. The app prompts you to position Solo so the camera is facing you and to ensure that the path it will follow (up and back) is clear. To continue, tap this screen.

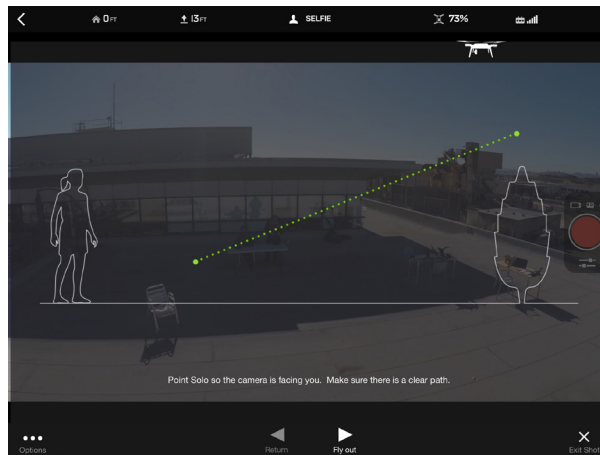

Figure 6.3.1.1: App - Selfie Activation

### 6.3.2 Selfie Operation

To move Solo along the Selfie path, tap the forward and back arrows in the App, labeled “Fly out” and “Return,” respectively. The default cruise speed when using Selfie is 9 mph (4 m/s).



Figure 6.3.2.1: App - Selfie Control

To control Selfie using the controller, use the right stick to move Solo forward and back along the Selfie path. To stop Solo at any time, press Pause. To exit to standard flight, press Fly.

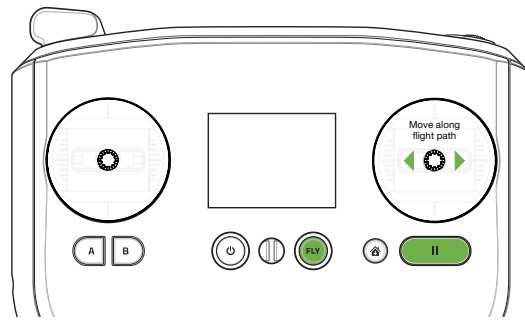

Figure 6.3.2.2: Controller - Selfie Control

### 6.3.3 Settings

To access the settings from the in-flight Selfie interface, select Options with the three dots at the bottom-left of the main screen. To adjust Distance Away, Altitude Up, and Cruise Speed, use the sliders.

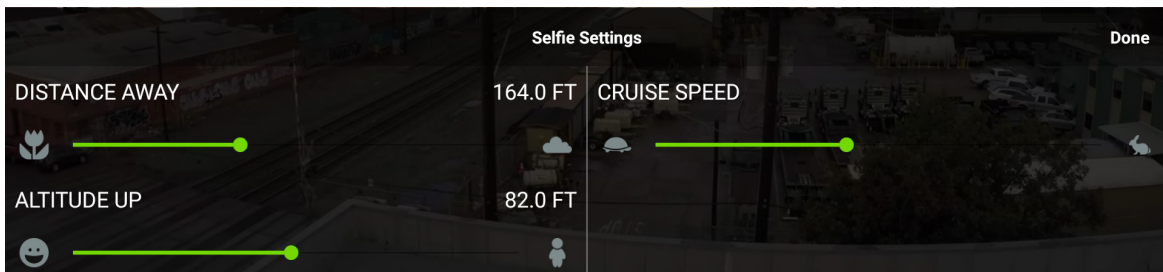

Figure 6.3.3.1: App - Selfie Settings



## 6.4 Cable Cam

Cable Cam creates a smooth shot by flying Solo automatically along a virtual cable between any number of waypoints that you specify initially. Basically, after starting the shot, you fly Solo to each successive waypoint in turn, press A on the controller, and so on. To save the last waypoint, press B, after which you can start Solo flying along its virtual cable.

### 6.4.1 Starting Cable Cam

To start Cable Cam, press A on the controller, or select Cable Cam from the Shot List in the App. You're then prompted to fly Solo to the start point and save it as the first Cable Cam point by pressing A. You can press A either on the Controller or on the App screen. Then fly to your next point and save it by pressing A again. Continue moving to new locations, pressing A at each point to save a waypoint. To finish recording waypoints, press B; this sets a final waypoint at the current location and switches to a mode where you can fly along the recorded cable.

Tip: While you're recording waypoints, for an impressive cinematic effect, try varying the altitude or orientation between successive points. Also, if you have the Solo 3-Axis Gimbal, try changing the view angle between the endpoints.

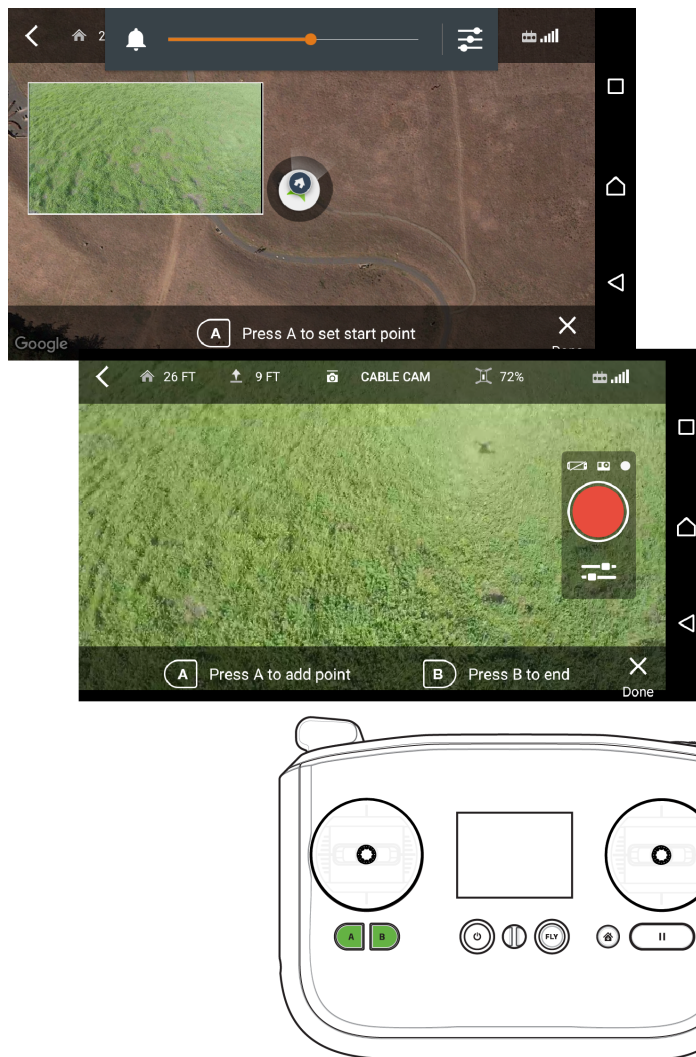

Figure 6.4.1.1: App - Cable Cam Setup

**Note:** Each Cable Cam waypoint must be at a different location than the one before it. If you try to set a second waypoint at the same position as the previous one, the new waypoint overwrites the previous one and you're prompted for another point.

## 6.4.2 Cable Cam Operation



Before running a Cable Cam shot, always ensure that the entire path is free of potential obstructions.



Figure 6.4.2.1: App - Cable Cam Controls

After you tap B to finish recording waypoints, the App switches to a screen that resembles the preceding illustration. The timeline near the bottom of the video image shows the number of waypoints and the relative distances between them, as well as the total amount of time it takes to fly the prerecorded route.

To control Cable Cam through the App, tap the right arrow at the bottom center of the screen to fly Solo through the sequence of waypoints in the order you recorded them, and the left arrow to fly through the waypoints in reverse order. When either of these is active, the arrow changes to a Pause symbol (||), which you can tap to make Solo stop and hover temporarily. Cable Cam's default cruise speed is set to 9 mph (4 m/s).

To operate Cable Cam using the Controller, move the right stick to the left to fly towards the start of the waypoint sequence and to the right to fly towards the endpoint. To pause at the current location, release the right stick.

To look left and right, enable Free Look (see Cable Cam Settings, following) and use the left stick. This overrides the recorded camera angles temporarily. To stop Solo at any time, press Pause. To exit to standard flight, press Fly.

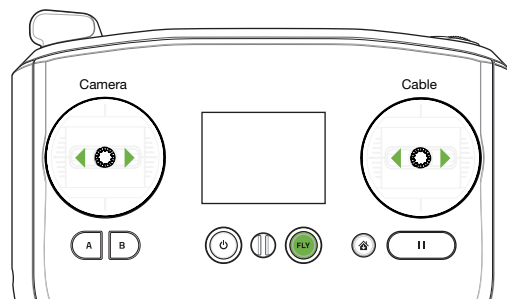

Figure 6.4.2.2: Controller - Cable Cam Controls

### 6.4.3 Cable Cam Settings

To access the settings from the in-flight Cable Cam interface, select Options with the three dots at the bottom-left of the main screen.

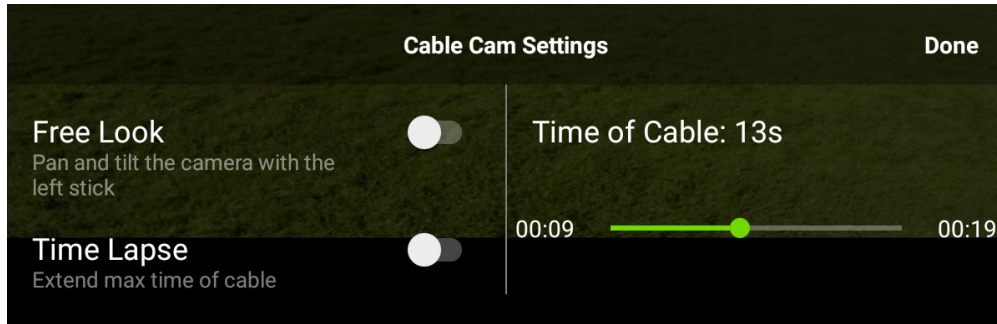

Figure 6.4.3.1: App - Cable Cam Settings with Time Lapse off

The settings consist of the following:

- **Free Look:** When on, you can adjust the direction in which the camera points with the controller left stick. When off, the camera points in the recorded direction.
- **Time Lapse:** When on, greatly increases the maximum Time Of Cable setting. Using a higher Time setting lets Cable Cam fly Solo much slower than you can manually, easily capturing slow-motion video.
- **Time of Cable:** This slider lets you change Solo's speed along the Cable Cam path by adjusting the total time it takes to travel the route. By default, it gives you a time range that slightly decreases the default time at the left end of the scale (thus traveling faster) and slightly increases it at the right end (thus traveling slower).

To change the speed, tap anywhere along the slider length or drag the small green time indicator. The "Time of Cable" readout shows the current amount of time Solo takes to travel the full length of the shot, based on the slider setting.

When Time Lapse is on, the maximum value for Time Of Cable increases greatly. For details, see Time Lapse (preceding).

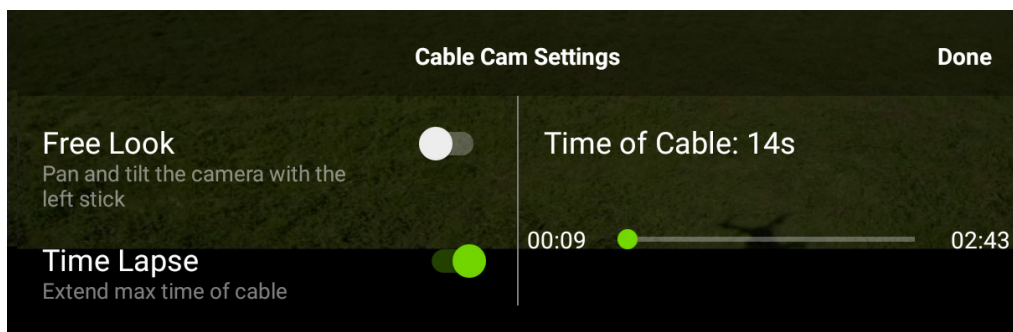

Figure 6.4.3.2: App - Cable Cam Settings with Time Lapse on

### 6.4.4 Saving Cable Cam Shots and Using Saved Shots

When you set up a Cable Cam shot in the Solo App, the app automatically saves the shot, including the general location and waypoints. The Saved Shots feature in the App lets you retrieve the shot at any time subsequently to repeat the Cable Cam shot exactly as you initially set it up.

When you tap the Shot List button on the main screen of the Solo App, the following screen appears:

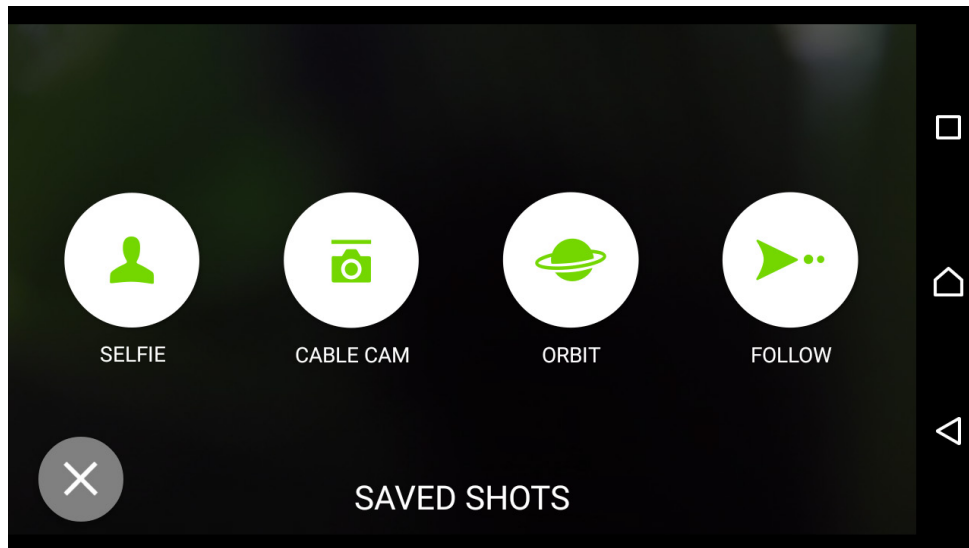

Figure 6.4.4.1: App - Cable Cam Smart Shots screen

To access the Saved Shots interface, tap the Saved Shots label near the bottom edge of the screen. Alternatively, to return to the previous screen, tap the X button at bottom left.

The Saved Shots screen looks like this:

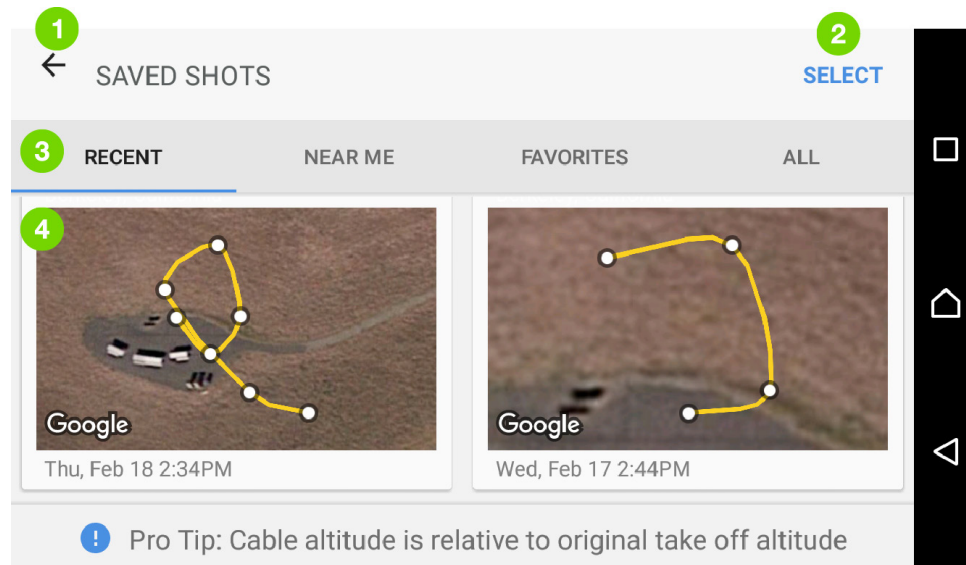

Figure 6.4.4.2: App - Cable Cam Smart Shots screen

The interface consists of options and control buttons at the top, and a scrolling list of saved-shot thumbnails below (4). The controls include the left arrow at top left (1), for returning to the previous screen, and the Select button at top right (2).

The additional controls (3) on the main Saved Shots screen--Recent, Near Me, Favorites, and All--let you filter the list of saved shots.

### 6.4.5 Deleting Saved Cable Cam Sequences

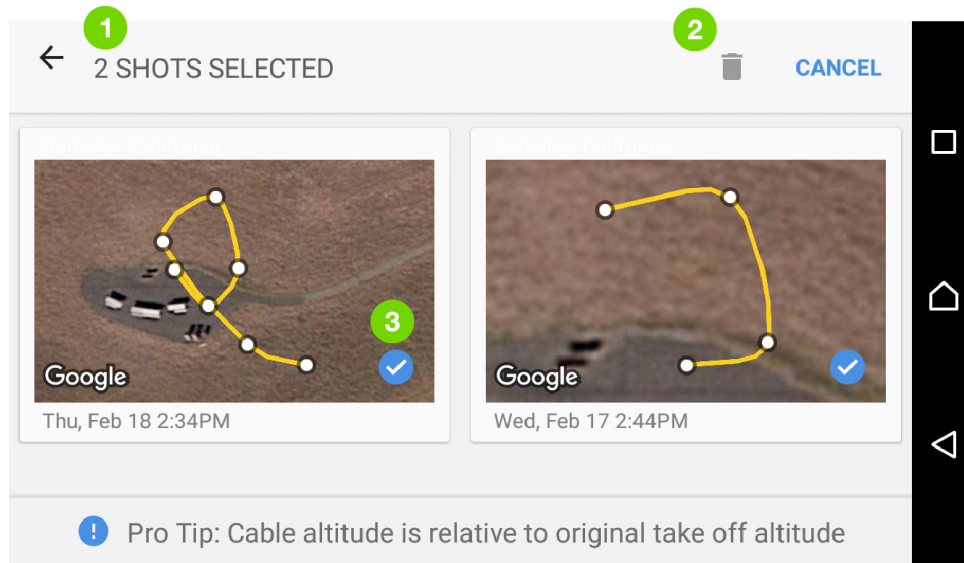

Figure 6.4.5.1: App - Selecting Saved Shots for Deletion

The Select feature allows you to delete multiple saved shots, as follows (refer to preceding illustrations): Tap Select, then tap the thumbnails for all the shots you want to delete. As you do so, a check-mark icon (3) appears on each selected thumbnail, and a message at the top of the screen (1) indicates the number of shots selected.

Once you've selected one or more saved shots, delete them by tapping the trash-can icon (2) at the top right, or tap Cancel to exit the deletion procedure.

### 6.4.6 Running a Saved Cable Cam Sequence

Each thumbnail shows a satellite image of the environment of the saved shot plus the path of the shot, with waypoints. To use a saved shot, tap its thumbnail. This takes you to a full-screen overhead view of the saved shot, plus several controls. If Solo's current location isn't quite close enough to where the Cable Cam shot was saved, the screen resembles this:

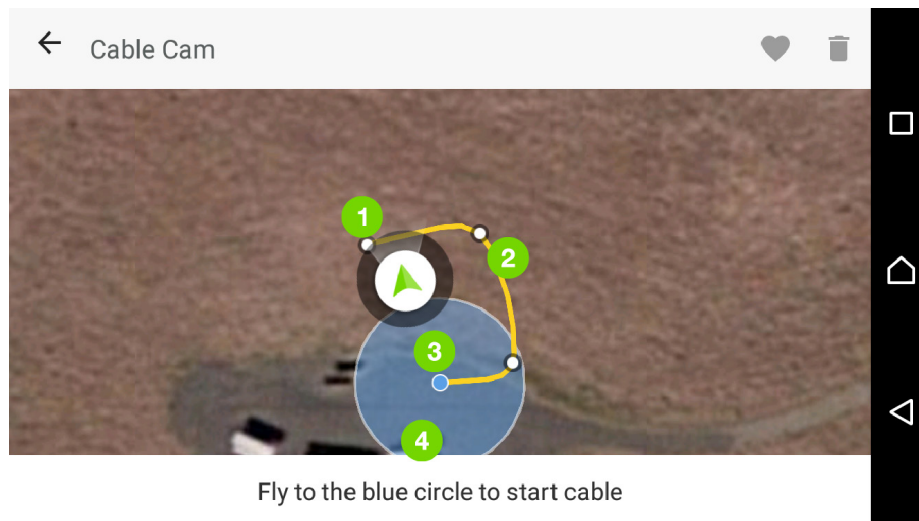

Figure 6.4.6.1: App - Prompt to Correct Solo Position

The green arrow (1) shows Solo's location and heading, the yellow line (2) indicates the path of the saved Cable Cam waypoint sequence, the small blue dot (3) represents the path's starting point, and the blue circle (4) shows the area within which Solo must be located before you can run the saved shot.

To use the recorded Cable Cam shot, fly Solo to any location within the blue circle. At this point, or if Solo was already close enough to the saved shot's starting point, you see a screen like this:

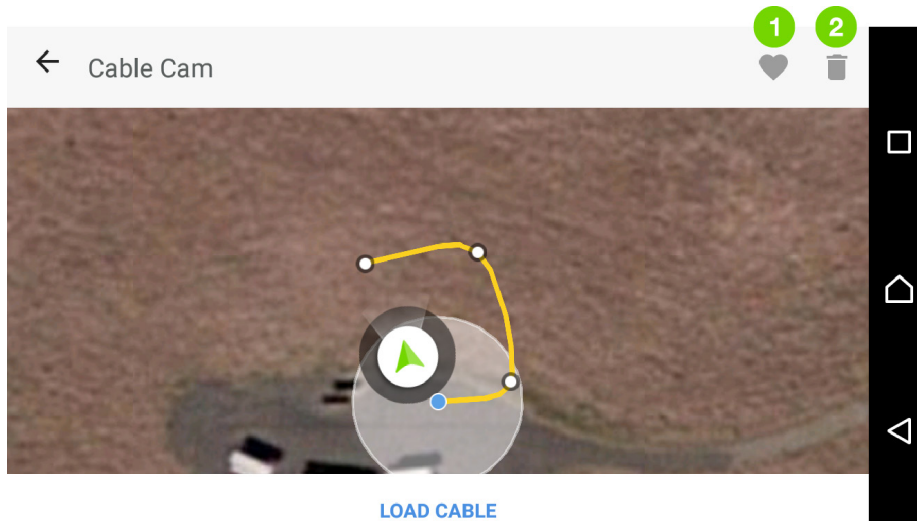

Figure 6.4.6.2: App - Prompt to load saved Cable Cam sequence

To use the saved shot, tap Load Cable. Alternatively, you can designate the saved shot as a “favorite” by tapping the heart-shaped icon (1) in the upper right, or delete it by tapping the trash-can icon (2). Any saved shots you “favorite” in this way subsequently appear in the Favorites listing on the main Saved Shots screen.

After you tap Load Cable, the app loads the saved-shot data and flies Solo to the starting point of the path. At this point you can run the saved shot the same way as any other Cable Cam shot.

## 6.5 Orbit

Use Orbit to fly Solo along a preset circle while fixing the camera on a central target.

**Note:** Orbit uses the Solo App’s mapping feature. For best results, use Orbit with a mobile device that has a live mobile data link. Alternatively, if using an Android device, you can use a cached map. For details, see Section 6.1.2, Map View, on page 39.

### 6.5.1 Starting Orbit

Select Orbit from the Shot List. The App switches to the map screen and shows the location Solo as well as the direction it’s facing on the map. This screen also shows the orbit center point as a small bullseye, as well as a line connecting the two points. To change the location of the center point, drag the map image in the App until the desired center point is at its center.

When the setup is satisfactory, press A on the controller to save the current center point. Once you set the center point, the App displays a Orbit Center Point Saved confirmation. To adjust the position of the center point during Orbit, drag the map.

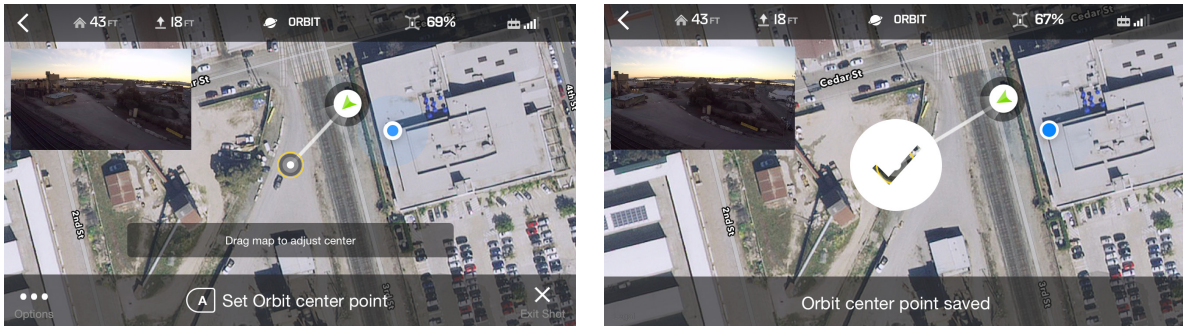

Figure 6.5.1.1: App - Orbit Setup

**!** Solo orbits at a constant altitude relative to its launch point, and does not account for changes in ground level. Be aware of any elevation changes at your location that would affect Solo. Before starting Orbit, always ensure there is a clear path for Solo.

## 6.5.2 Orbit Operation

To fly Solo along the Orbit path, tap the left and right arrows at the bottom of the app screen, labeled Orbit Left and Orbit Right. The default cruise speed for Orbit is 2.2 mph (1 m/s).

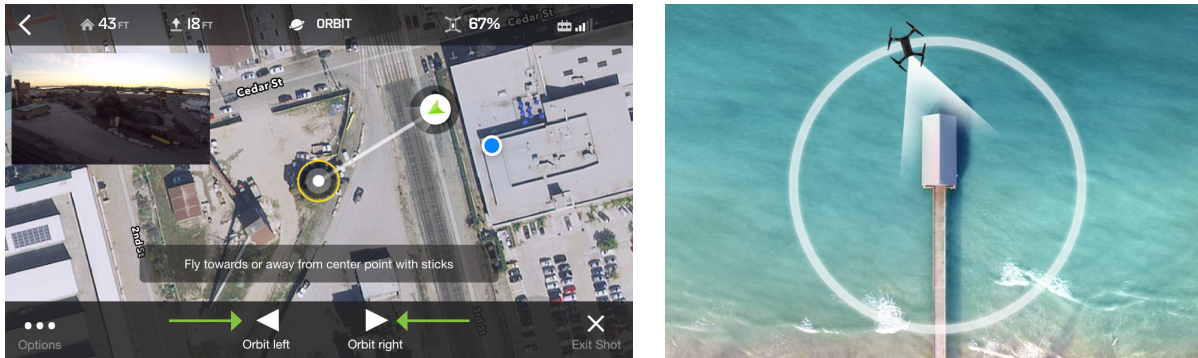

Figure 6.5.2.1: App - Orbit Controls

To control Orbit using the controller, move the right stick left and right to fly Solo along the Orbit path. You can move Solo toward and away from the subject by pushing the right stick up and down, respectively. To temporarily override the camera's lock on the subject and look left and right, move the left stick. To adjust Solo's altitude, move the left stick up and down. If you have the Solo Gimbal installed, you can change the pitch of the camera with the paddle on top of the controller. To stop Solo at any time, press Pause. To exit standard flight, press Fly.

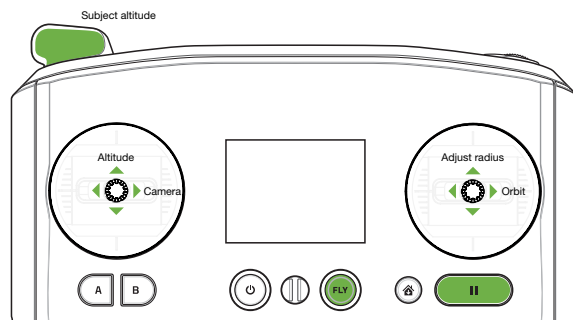

Figure 6.5.2.2: Orbit Controls

### 6.5.3 Orbit Settings

To access the settings from the in-flight Orbit interface, select Options with the three dots at the bottom-left of the main screen. To adjust Cruise Speed, use the slider.

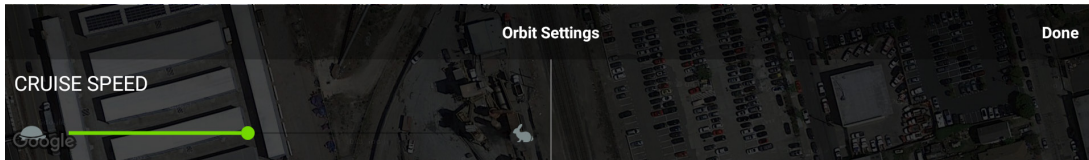

Figure 6.5.3.1: App - Orbit Settings

## 6.6 Follow

Follow creates a virtual tether between Solo and your GPS-enabled mobile device, allowing Solo to track you as you move. Follow has two modes:

- **Look At Me:** Solo remains in one place while turning to face the subject.
- **Follow:** Solo moves at the same rate as the subject while continually aiming the camera at the subject. In this mode you have the additional option of orbiting manually around the subject, as well as operating the camera independently.

**Important:** To use Follow, your mobile device must have GPS capability. Most smart phones have GPS built in, but some tablets, such as Wi-Fi-only models of the iPad, do not.

If the Follow subject is engaged in an activity that prevents them from using the controller, you are required to use a safety pilot during Follow. The subject carries the mobile device and is followed by Solo, and the safety pilot holds the controller and is ready to regain manual control at any time.

Don't exceed 500 feet of distance between the controller and the mobile device; however, specific range limits depend on the device being used. If too much distance is allowed between the controller and the mobile device, the device could lose connection with the controller.



Always ensure that there is a clear path for Solo during Follow. It does not avoid obstacles that come into the flight path as a result of following the subject.

### 6.6.1 Follow Setup

To start Follow, select Follow from the Shot List in the app and navigate Solo to face the subject. When Follow starts, it's in Look At Me mode, in which Solo remains stationary while turning to face the subject as they move. To activate Follow mode, in which Solo moves along with the subject, tap Follow at the bottom of the screen. You can switch between the two modes at any time while using Follow. The App indicates the active mode with green text and icon.



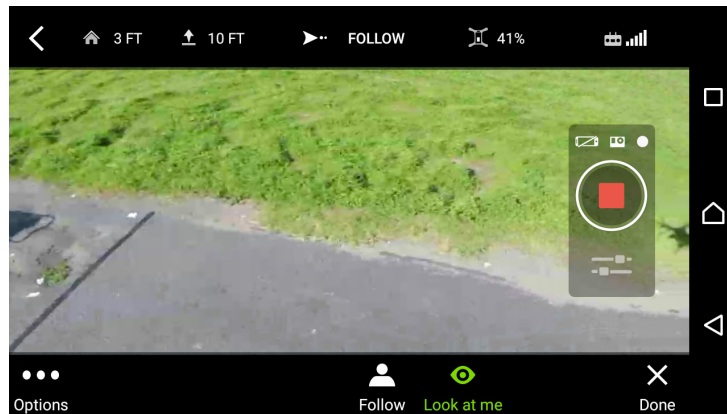

Figure 6.6.1.1: Follow in Look At Me mode

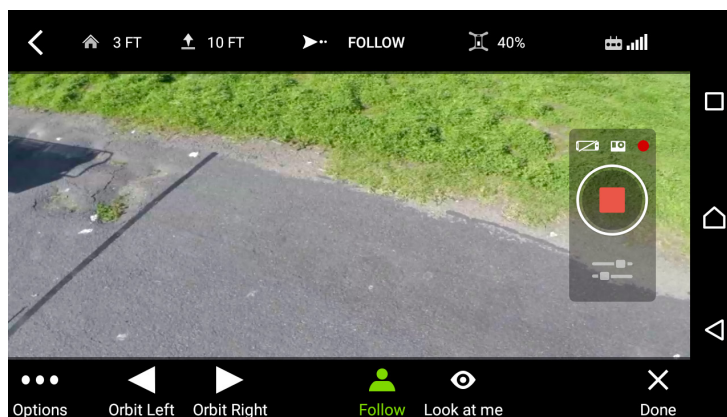

Figure 6.6.1.2: Follow in Follow mode

### 6.6.2 Follow Mode Operation

When Follow mode is active, Solo automatically follows the mobile device wherever the subject carries it. In the App, the subject can orbit Solo around them by pressing the Orbit Left and Orbit Right arrows.

On the Controller, adjust the follow distance by moving the right stick vertically, and orbit the subject by moving the right stick horizontally. To adjust Solo's altitude during Follow, move the left stick vertically. And to override the camera tracking and temporarily pan the camera, move the left stick horizontally. To stop Solo during Follow, press Pause on the controller; the camera continues to track the subject. To exit to standard flight, press Fly.

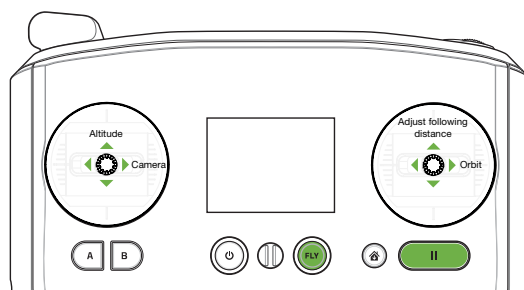

Figure 6.6.2.1: Follow Controls

### 6.6.3 Follow Settings

When using Follow in Follow mode (Solo moves along with the subject), by default the camera remains pointed at the subject no matter what its position is. However, you have the option in this mode to control the camera independently with the left joystick on the controller. This option is known as Free Look.

To enable Free Look, make sure Follow is set to Follow mode, then tap the Options button (three dots) in the bottom-left corner. The following Settings screen opens:

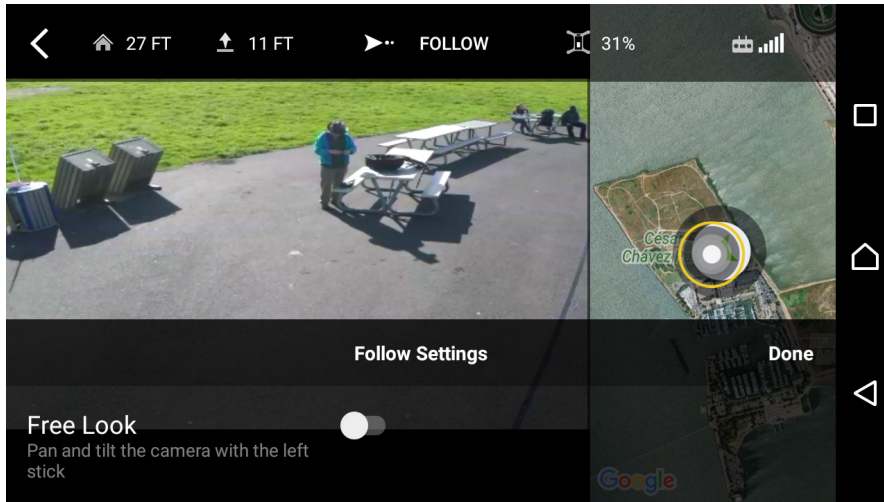

Figure 6.6.3.1: App - Follow Settings

To turn on Free Look, tap its toggle switch. At this point, the following screen opens:

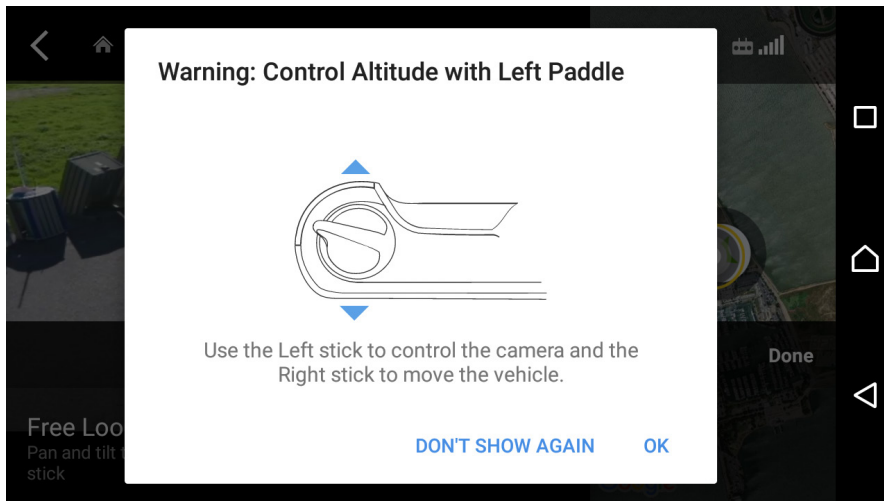

Figure 6.6.3.2: App - Free Look warning

Read this message, then tap OK to continue. Then, while flying using Follow with Free Look, remember that you now use the Controller left stick exclusively to control the direction the camera points, and the left paddle on the top edge of the Controller to control Solo's altitude.

# 7 Alerts

The following alerts will appear on the controller in the event of a preflight or in flight error. Always monitor the controller for alerts and perform the recommended actions.

## 7.1 Preflight Errors

Before starting the motors, Solo runs a series of automatic checks to ensure that the system is ready for flight. If Solo encounters an error during these preflight checks, the controller will display the encountered error along with instructions for the corresponding calibration to perform.

### 7.1.1 Calibration

The following errors indicate that a preflight check is in progress: altitude calibrating, calibrating solo, and calibrating compass. Please wait for the error to clear before continuing.

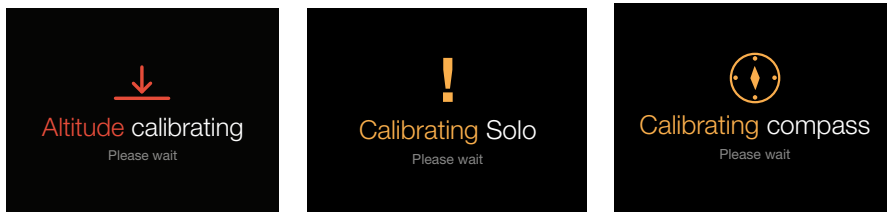

Figure 7.1.1.1: Controller - Calibration in Progress Alerts

If Solo is not placed on a level surface, you will receive the following alert to move Solo to a level surface for takeoff.

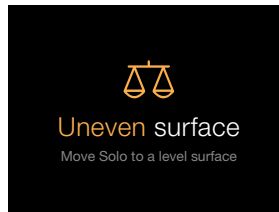

Figure 7.1.1.2: Controller - Uneven Surface Alert

If Solo requires manual calibration, the following alert messages show the displays for compass and level calibrations. Refer to Section 10.2 for compass- and level-calibration instructions.

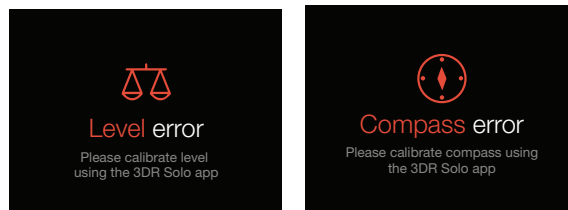

Figure 7.1.1.3: Controller - Re-Calibration Required Alerts

If a calibration or sensor error occurs during startup, one of the following alerts appears. To clear the error, restart Solo.

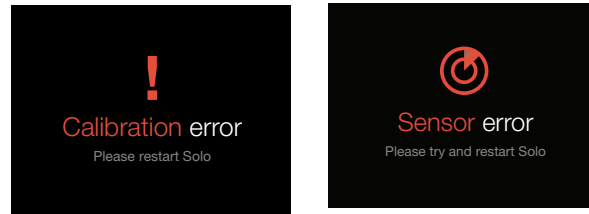

Figure 7.1.1.4: Controller - Calibration Error Alert

### 7.1.2 Service Alerts

The following alerts indicate a system error that requires service. Use the app to submit a trouble ticket with 3DR Support or contact an authorized Solo Service Center to service Solo and clear the alert. A control stick error can occur either in flight or before takeoff. If the control stick error is received in flight, Solo will return home and land.

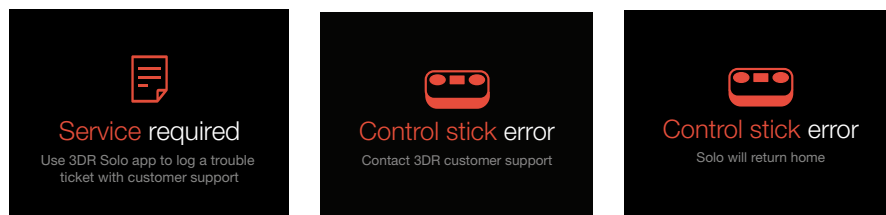

Figure 7.1.2.1: Controller - Service Alerts

## 7.2 In-Flight Errors

During flight, the controller monitors Solo's GPS signal, controller signal, flight battery level, and controller battery level.

### 7.2.1 Altitude Limit

If Solo reaches the altitude limit during flight, maintains that altitude and the controller displays the following alert.

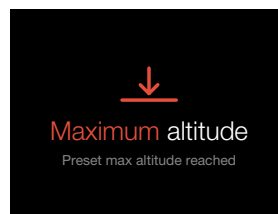

Figure 7.2.1.1: Controller - Altitude Limit Alert

### 7.2.2 App Connection

We recommend maintaining an active connection to the Solo app at all times during flight. For information about connecting to Solo Wi-Fi with the App, refer to Section 2.6. If the connection to the App is lost during flight, Solo will not return home. If the Solo App connects to or disconnects from Solo during flight, the controller displays the following banner-type alerts:

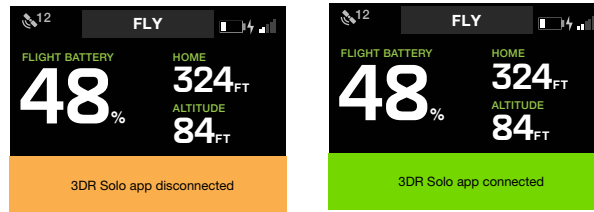

Figure 7.2.2.1: Controller - App Connection Alerts

### 7.2.3 Controller Signal Alerts

Flying behind solid objects, like buildings and trees, blocks communication signals between Solo and the controller. Always maintain visual contact with Solo to ensure that the signal is unobstructed. Cell phone towers and nearby Wi-Fi signals can cause interference with the communication system and decrease its range. To prevent signal interference, avoid flying in populated areas.

If the controller becomes unpaired from Solo during flight, the controller displays the following alert and Solo initiates Return Home. See Section 10.3 for pairing instructions.

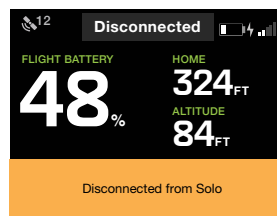

Figure 7.2.3.1: Controller - Controller Disconnected Alert

If the signal between Solo and the controller is lost during flight, the controller displays the “Controller signal lost” alert and Solo initiates Return Home. If signal is recovered while returning home, the controller displays the “Signal recovered” alert and provides the option to regain manual control by pressing the Fly button.

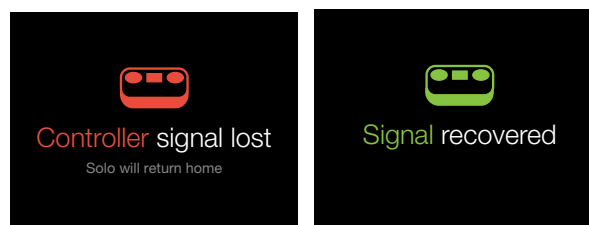

Figure 7.2.3.2: Controller - Controller Signal Alerts

### 7.2.4 GPS Signal Alerts

If Solo loses GPS during flight, it switches into Fly:Manual. If this happens, we recommend that you land Solo and wait to acquire GPS lock before taking off again.

In Fly:Manual, Solo uses the same joystick controls as in standard flight (displayed as “Fly”), but it does not use GPS positioning. Thus, Solo does not hold its position when you release the right stick, so you must maintain close control over roll, pitch, and yaw. Without GPS, Pause, Return Home, and Smart Shots are not available. During Land, Solo cannot maintain position due to the lack of GPS positioning, and drifts according to wind and other environmental conditions. If another alert occurs while Solo is in Fly:Manual, Solo cannot return home and instead

initiates a non-positioned landing at the current location.

If Solo recovers GPS during flight, Solo switches from Fly:Manual to standard flight (Fly), and GPS positioning activates. The following displays show (from left to right) the “GPS lost” alert, Solo in Fly:Manual, and “GPS recovered” alert. For optimal GPS signal strength, always choose a location with a clear view of the sky.

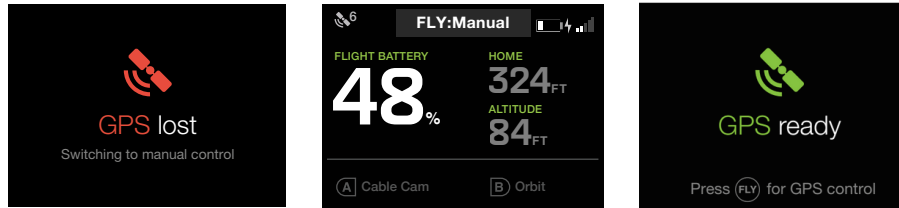

Figure 7.2.4.1: Controller - GPS Signal Alerts

### 7.2.5 Flight Battery Alerts

The controller monitors the Solo battery during flight and displays alerts when the battery reaches critical levels. At 25% and 15% power remaining, the controller displays a “Return home soon” alert recommending that you end your flight to prevent an automatic landing.

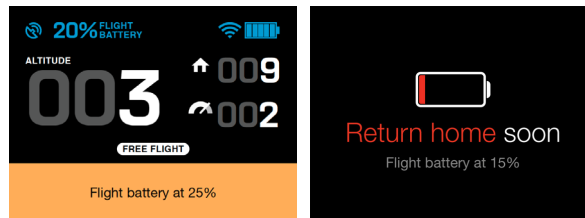

Figure 7.2.5.1: Controller - Low Battery Alerts

If the battery reaches 10%, Solo initiates Return Home to prevent a crash. After landing, turn off Solo immediately; if the battery level reaches 0% at any time, irreversible damage occurs and the battery should be recycled.

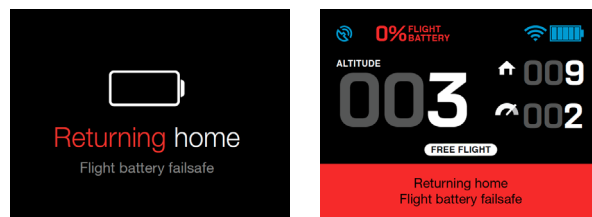

Figure 7.2.5.2: Controller - Critical Battery Alert

### 7.2.6 Controller Battery Alerts

When the controller battery level reaches 10%, the controller displays an alert to notify you to charge the controller at your next opportunity. At 5%, the controller prompts you to end your flight and charge the controller. If the controller battery reaches a critical level in flight, Solo initiates Return Home. The following displays show (left to right) the 10%, 5%, and 0% alerts:

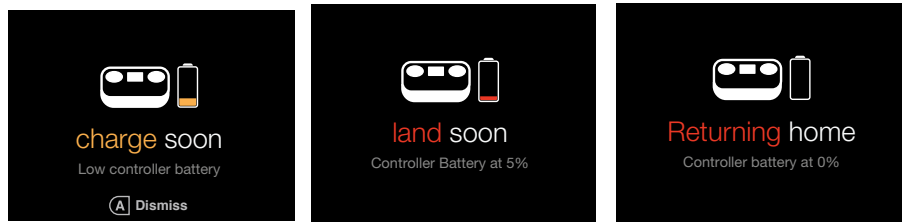

Figure 7.2.6.1: Controller - Controller Battery Alerts

## 8 Advanced Settings

This section provides instructions for accessing and using Solo's advanced features and settings.

### 8.1 Advanced Flight Modes

Are you a quadcopter pro? We designed Solo to be simple and reliable, but also really fun to fly. Solo includes five advanced flight modes: Fly:Manual, Stabilize, Acro, Sport, and Drift. To access these modes, see sections 8.2 and 8.3, following.



Advanced flight modes are for experienced operators only. Do not attempt to use these modes unless you are comfortable flying multicopters without positioning and altitude assistance.

#### 8.1.1 Fly:Manual

Fly:Manual mode is a version of standard flight without GPS lock. In Fly:Manual, the throttle stick controls altitude the same way as standard flight (Fly mode). However, because it does not use GPS positioning, when you release the right stick, Solo does not hold its position but instead drifts according to wind conditions and existing momentum. To control Solo's position when flying in Fly:Manual mode, adjust the right stick continually and use the left stick to maintain Solo's orientation.

#### 8.1.2 Stabilize

Stabilize mode provides full manual control without autopilot assistance. In Stabilize, the autopilot regulates Solo's roll and pitch angles so that it automatically returns to level when you release the right stick. The throttle stick controls power and acceleration directly; it does not correspond to altitude. Stabilize requires fine control of both the left and right sticks to fly Solo. Stabilize does not require GPS lock.

#### 8.1.3 Drift

Drift modes requires GPS lock and provides a plane-like flying experience. Drift is ideal for navigating Solo using the video feed. This is known as first-person view (FPV) and provides an immersive flying experience. In Drift, you control roll, pitch, and yaw with the controller's right stick. To navigate Solo in Drift mode, move the right stick to initiate a coordinated turn in that direction. Releasing the right stick causes Solo to drift to a stop over a two-second period. Solo does not automatically control altitude in Drift, and thus requires continual adjustments to the throttle stick in this mode.

#### 8.1.4 Acro

Acro is the most advanced of Solo's flight modes. It provides unrestricted control over Solo's roll and pitch angles. Acro is intended for performing aerial acrobatics, flips, and maneuvers requiring extreme angles. Acro provides no altitude or position assistance, so be prepared to make constant adjustment to both sticks. Acro is a copter-frame-oriented mode, meaning that, in Acro, Solo always responds to controls relative to its own orientation. Acro does not require GPS lock.



Do not fly in Acro mode unless you are an extremely experienced operator. Without the proper skills, crashes in Acro are highly likely.

#### 8.1.5 Sport

Sport mode is a modified version of Acro that includes altitude assistance and earth-frame orientation. With altitude assistance, the throttle stick behaves the same in Sport mode as it does in standard flight (Fly mode). Earth-frame orientation differs from copter-frame orientation in that the direction of yaw rotation is in relation to the earth instead of in relation to the copter itself. For example, if Solo is pitched forward in sport mode and left yaw is applied, Solo will maintain the same pitch angle and rotate around the vertical axis. As opposed to in acro's copter-frame orientation, in which, in the same situation, Solo will perform a cartwheel. Sport does not require GPS lock.



## 8.2 Enabling Advanced Flight Modes

To unlock Solo's advanced flight modes using the App, choose Settings from the home screen, then select Advanced Settings. Toggle the Enable Advanced Flight Modes option to gain access to Solo's advanced modes.

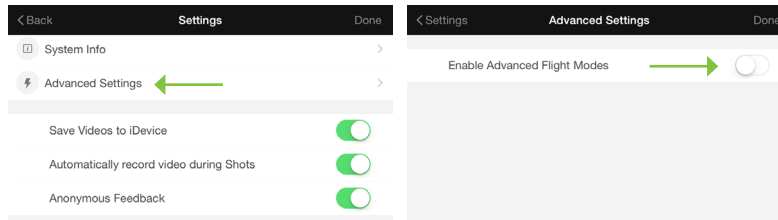

Figure 8.2.1: App - Advanced Settings

## 8.3 Accessing Advanced Flight Modes

After you enable advanced flight modes, you can access them only by assigning them to the controller's A and B buttons using the App. In the app, go to Settings > Solo and select Preset A or Preset B settings list. (The app must be connected to Solo to apply button assignments.) Once assigned, use the controller to activate advanced modes during flight.

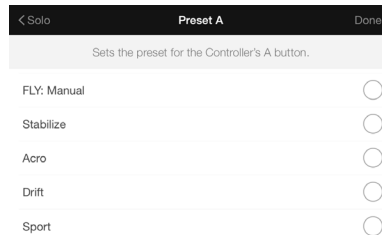

Figure 8.3.1: App - A and B Presets

## 8.4 Home Position Safety

Fly:Manual, Stabilize, Acro, and Sport modes do not require GPS lock. To take off without GPS lock, Solo must be set to one of these modes. Without an active GPS signal, Return Home, Pause, and Smart Shots are disabled. If you take off without GPS lock, Solo does not save a home position at the launch point. If Solo acquires GPS lock mid-flight, the autopilot saves a home position at that location. To prevent a potentially unsafe situation, do not use Return Home if Solo did not acquire GPS prior to takeoff.



If Solo did not acquire GPS lock prior to takeoff, do not use Return Home.

## 8.5 Performance Adjustment

The Solo app includes options to adjust Solo's performance to suit your flying style. To access the performance sliders, go to Settings, choose Solo, and then select Performance. The Flight slider controls how fast Solo flies and its responsiveness to controls. The Camera Pan slider regulates the speed that Solo rotates. Move the slider towards the turtle for slower, more cushioned movement, or move the slider towards the rabbit for faster, more responsive movement.

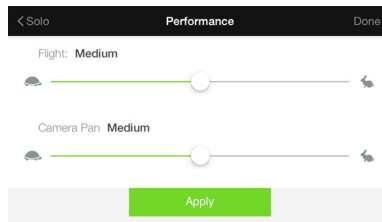

Figure 8.5.1: App - Performance Sliders

**Tip:** When using the Solo Gimbal, for best results set Performance to Medium.

## 8.6 Units

To change the units in the Solo App between imperial and Metric, go to Settings and then choose Units.

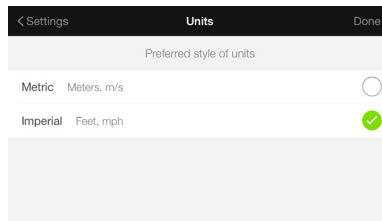

Figure 8.6.1: App - Change Units

## 8.7 Maximum Altitude Adjustment

To adjust the altitude limit, go to Settings, choose Solo, and then select Altitude Limits. Scroll the list horizontally to change the upper limit.

A No Limit option is available if you turn on Advanced Settings > Enable Advanced Flight Modes. If you opt for No Limit, ensure that you always operate Solo within your visual line of sight and in compliance with local regulations.

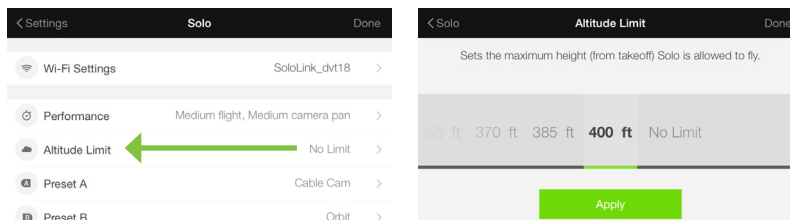

Figure 8.7.1: App - Altitude Limit

## 8.8 Map Tile Provider (Android only)

If your device supports mobile data (typically a cell phone), you can view a map of your surroundings by swiping left on the main screen in the Solo App. This setting lets you choose whether the map data comes from Google or Map

Box. If you're using mobile data, the choice is up to you, but if you're using a Wi-Fi-only device, we recommend that you use Map Box in order to be able to cache map data. For more information, see section 6.1.2 on page 39.

## 9 Support

3DR Support is here to help you get the most out of Solo. If you have any questions, send an email to support@3dr.com or give us a call at 1 (855) 982-2898 (toll free in the US and Canada) or direct at +1 (858) 225-1414. To submit a support request through our website, visit 3dr.com/support.

Use the Solo app to submit a trouble ticket; this automatically sends your flight logs be sent to 3DR Support. To submit a support request within the Solo app, select Support from the home screen, tap Contact Us, and select Log Trouble Ticket.

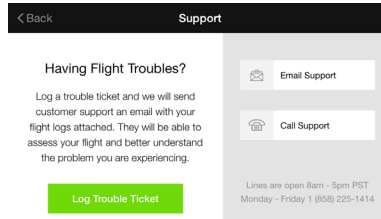

Figure 9.1: App - Submit Trouble Ticket

## 10 Maintenance

This section covers basic operational maintenance procedures for Solo. For repairs not covered in this manual, contact 3DR Support or an authorized Solo Service Center.

Solo's exterior components are designed to absorb impact from hard landings and protect the core electronics. If damage is sustained to Solo's legs or motors, replace them with official 3DR parts from [store.3dr.com](http://store.3dr.com) or an authorized retailer. 3DR offers an extended controller battery upgrade with double the capacity so you can fly longer between charges. Before opening the battery bay or performing any maintenance on Solo, always ensure that Solo is powered off with the battery removed.

### 10.1 Controller Battery Replacement

To replace the controller battery, open the battery door on the back of the controller. Remove the foam block and disconnect the battery from the port in the side of the battery compartment. To install a battery, connect the battery to the controller, and, for standard-size controller batteries, use the foam block to pad the empty space in the compartment. For information on safely storing spare controller batteries, see Section 4.10.

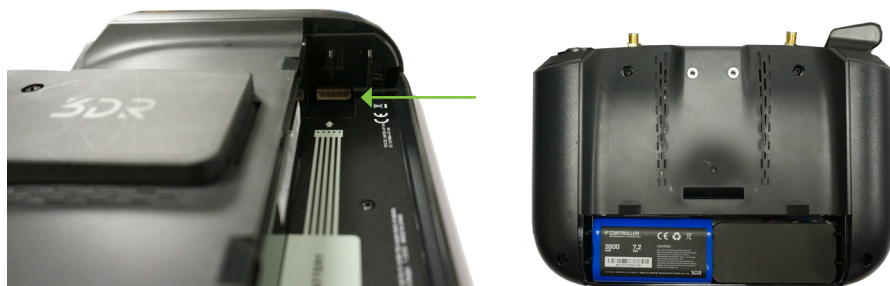

Figure 10.1.1: Controller Battery Installation

### 10.2 Calibrations

Use the Solo app to perform compass and level calibrations when prompted by the controller. Remove Solo's propellers before performing calibrations.

#### 10.2.1 Compass Calibration

To calibrate Solo's compass, connect the app to Solo Wi-Fi, go to Settings > Solo and select Compass Calibration. Ensure that Solo and the controller are powered on with the propellers removed. Solo requires an interference-free environment for compass calibration, so ensure that you are away from metal buildings, reinforced concrete, or other metal structures before starting calibration.

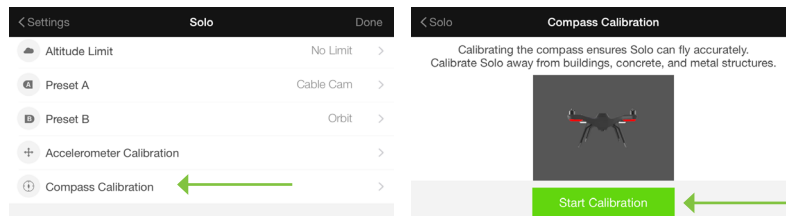

Figure 10.2.1.1: App - Compass Calibration Setup

The app prompts you to rotate Solo end-over-end multiple times until the bar at the top of the screen is completely green. If the calibration fails, move to a different location and try again.

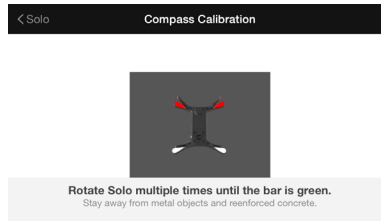

Figure 10.2.1.2: App - Compass Calibration Procedure

## 10.2.2 Level Calibration

A level calibration zeroes Solo's accelerometers to recognize static states. To perform a level calibration, remove the propellers from Solo and connect the app to Solo Wi-Fi. Go to Settings Solo and choose Level Calibration from the list, and follow the prompts to place Solo perfectly still on each side in turn. In each step, wait a few seconds after moving Solo to press Next.

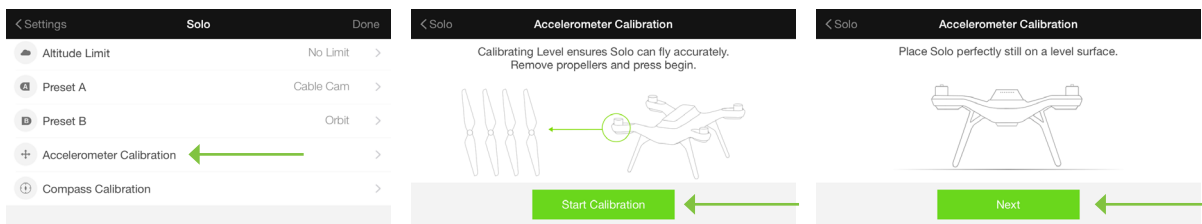

Figure 10.2.2.1: App - Level Calibration

## 10.3 Pairing the Controller

1. Turn off the Solo and the controller that you want to pair, along with any other Solos and controllers nearby.
2. Power on the Solo and controller that you want to pair.
3. Wait 30 seconds for Solo and the controller to fully boot up.
4. Identify the Pair button underneath Solo. It's a small button inside the hole labeled Pair. You'll need to use a paper clip, a small screwdriver, or another similar tool to push it.



Figure 10.3.1: Pair Button

5. Press the Pair button underneath Solo and hold for one second.
6. When the controller detects Solo, it prompts you to accept the pairing request as seen in the screen below. (If the controller does not detect Solo after thirty seconds, try pressing the Pair button underneath Solo again and repeat as needed.)

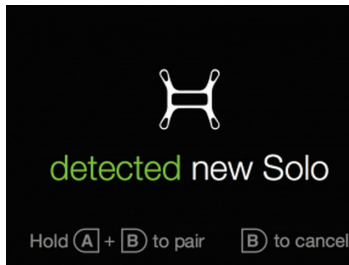

Figure 10.3.2: Detected Solo

7. Press A, then B and hold both buttons down. Once the controller vibrates, release the buttons. Within 20 seconds, the Controller displays “Solo Paired.”



Figure 10.3.3: Solo Paired

## 10.4 Legs

Solo uses three unique types of legs: two legs with an antenna module (#1 and #2), a leg with no electronic components (leg #3), and a leg with a compass module (leg #4). You can purchase replacements for all types of leg from [store.3dr.com](http://store.3dr.com) or an authorized retailer.

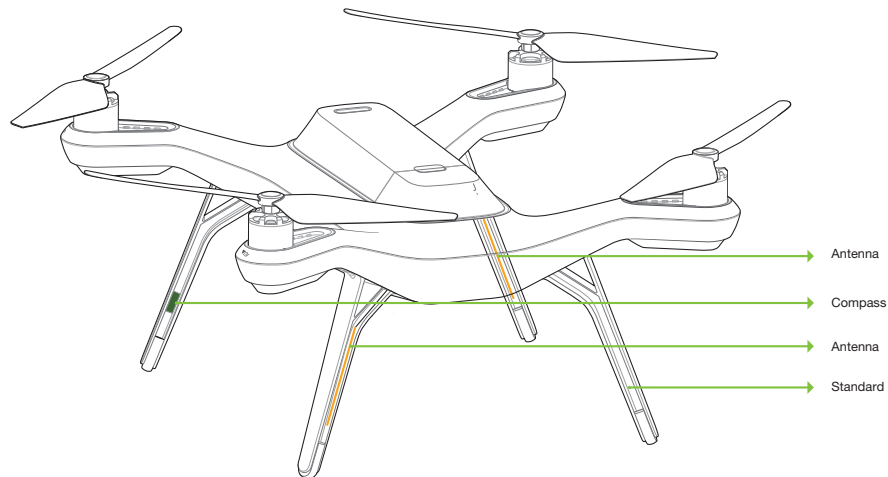

Figure 10.4.1: Leg Types

### 10.4.1 Leg #3

To replace a standard leg, use a #2 Phillips screwdriver to remove the two screws, detach the old leg, and attach the new leg using the provided screws.

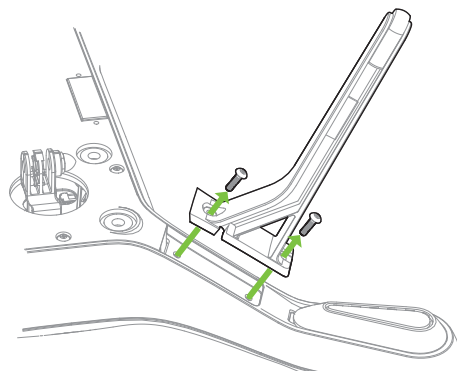

Figure 10.4.1.1: Standard Leg Replacement Process

### 10.4.2 Legs #1 and #2 with Antennas

To replace a leg with an antenna module where the existing antenna is physically intact, you'll need to remove the antenna from the old leg before replacing it.

To detach the antenna, remove the plastic sheet from the leg (1) and detach the antenna from the Velcro by carefully pulling the cable (2). Follow the standard leg replacement procedure to detach the old leg (3).

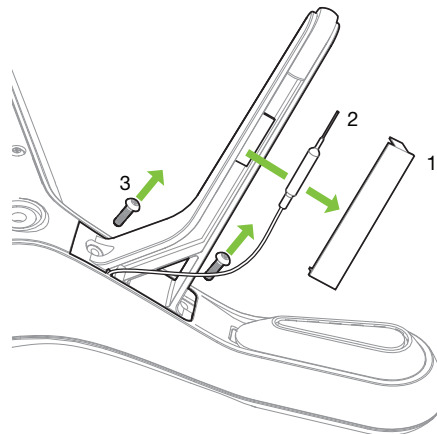

Figure 10.4.2.1: Detaching the Antenna from the Leg

Attach the new leg by threading the antenna cable through the notch in the top of the leg (1) and securing the leg using the provided screws (2).

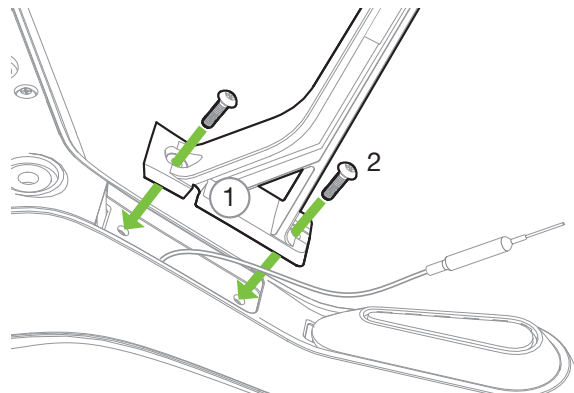

Figure 10.4.2.2: Attaching a New Leg with an Existing Antenna

To secure the antenna to the new leg, use the provided Velcro to attach only the yellow-backed Velcro strip to the Velcro on the antenna. Then remove the backing and attach the Velcro and antenna to the inside of the leg, placing the tip of the antenna five mm from the edge of the rubber foot (1) as shown in the following illustration. Fold the ends of a provided plastic sheet at right angles (2), remove the adhesive backing, and stick the plastic sheet to the leg so it secures the antenna in place (3).

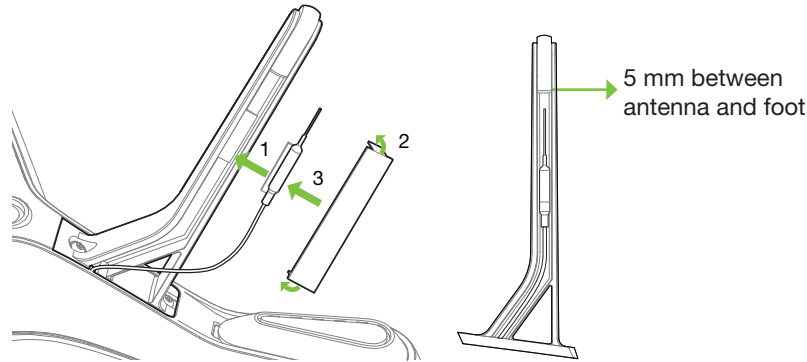

Figure 10.4.2.3: Attaching an Existing Antenna to a New Leg

### 10.4.3 Leg #4 with Compass

Solo's right-rear leg (#4) contains the compass module. Start by detaching the leg from the arm as you would a standard leg, but the leg will not be removable until you disconnect the compass from Solo. To access the compass connector, you'll need to remove the battery tray from Solo. For battery tray removal instructions, see Section 10.5.

With the battery tray removed, locate the compass connector in the corner of the board closest to the leg being replaced. Disconnect the compass connector from the board by holding down the tab on the far side of the connector and lifting up the connector. Because the space between the arm and the connector is limited, it might help to use a screwdriver to press the tab.

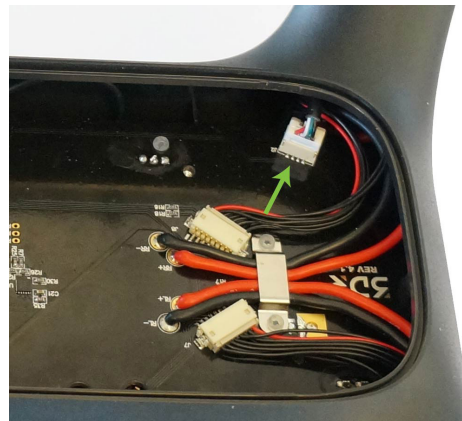

Figure 10.4.3.1: Compass Connector on Mainboard

With the compass disconnected, remove the old leg and cable from Solo. Place the new leg into position and thread the new compass cable through the arm where it can connect to the board. Connect the compass connector in the same place as the old compass.





Figure 10.4.3.2: Insert New Leg with Compass

Secure the new leg in place and replace the battery tray.

## 10.5 Battery Tray

The battery tray holds the battery and GPS in place, and allows you to access the main electronics bay. This section covers how to remove the tray to access the interior of Solo.

### 10.5.1 GPS Cover

The GPS cover is the flat, black end cap in front of the battery tray. To remove the GPS cover, use your fingernails (1) to release the side clips outward. Next, lift slightly while pushing forward (2) to pop the cover off completely.

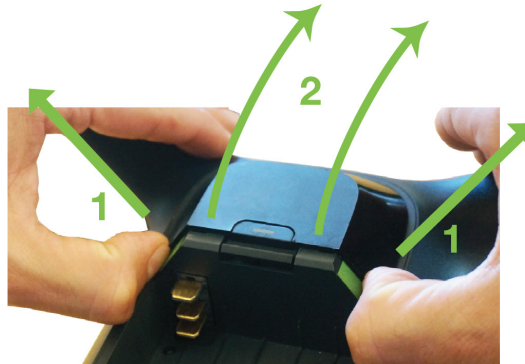

Figure 10.5.1.1: GPS Cover Removal

### 10.5.2 Battery Tray Removal

To detach the battery tray and access Solo's main electronics bay, use a small Philips screwdriver to remove the seven screws securing the battery tray to Solo.



Figure 10.5.2.1: Battery Tray Removal

The battery tray is still connected to Solo via the GPS cable, so carefully lift out the tray just enough to access the board beneath.

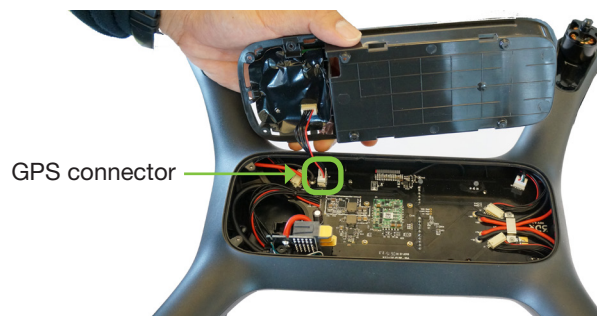

Figure 10.5.2.2: Battery Tray Detachment

## 10.6 Motor Mods

Replacement motors are available as clockwise and counterclockwise Motor Pods. Use a counterclockwise Motor Pod to replace motors #1 and #2, and use a clockwise Motor Pod to replace motors #3 and #4. Replace motor pods after every 150 hours of flight or when they can no longer turn smoothly.

To replace a Motor Pod, first use a small, flat prying tool to remove the LED cover from the underside of the arm.

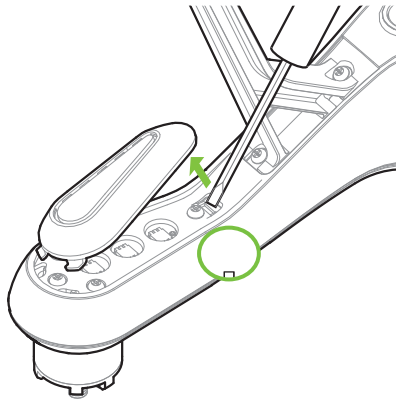

Figure 10.6.1: LED Cover Removal

Use a #2 Phillips screwdriver to remove the four screws securing the pod to the arm.

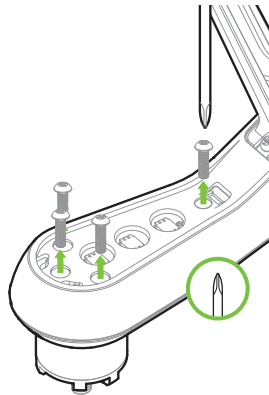

Figure 10.6.2: Motor Pod Removal

Disconnect the wide beige connector, the red wire and the black wire to remove the old motor pod. To remove the wide beige connector (DF13), carefully lift the edges of the connector away from the pod until they pop out, then remove the connector. Don't pull on the wires! The connector can break easily you use force to remove it.

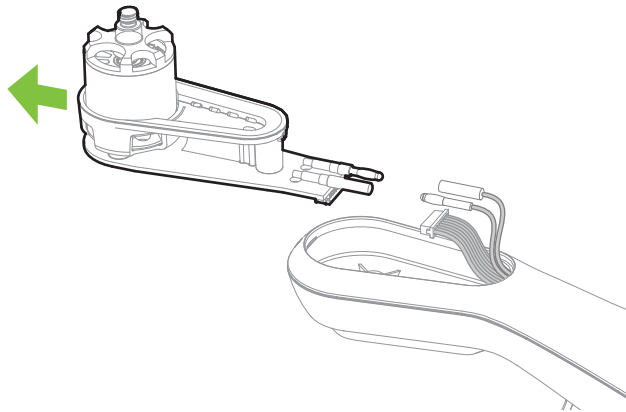

Figure 10.6.3: Motor Pod Disconnection

Connect the three cables from the arm to the new motor pod. Tuck the cables inside the arm and set the new pod into place.

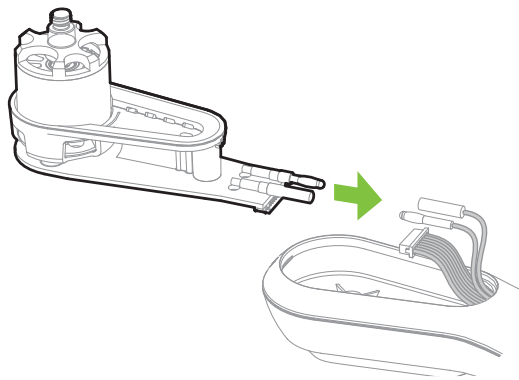

Figure 10.6.4: Motor Pod Connection

Turn over Solo and secure the new motor pod into place using the four provided screws. Do not reuse the screws from the old Motor Pod. Finally, snap the LED cover **back into place**.

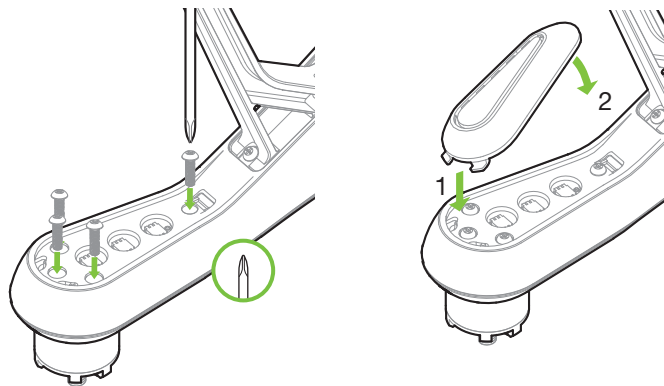

Figure 10.6.5: Motor Pod and LED Cover Attachment

## 10.7 Factory Reset

Performing a factory reset restores Solo and the controller to their state prior to the first flight update. Use a factory reset if you forget your Solo Wi-Fi password or need to restore Solo's factory settings.



Contact customer support before performing a Factory Reset. This procedure can cause irreparable damage to Solo.

### Step 1: Reset the Vehicle

As part of the reset procedure, Solo is un-paired from the Controller. Start by powering off Solo. Use a paper clip or similar tool to press and hold Solo's Pair button while powering on Solo. (Make sure you feel the Pair button click down underneath the paper clip to verify you have properly activated the Pair button.) Continue holding the Pair button *for at least 15 seconds*.



Figure 10.7.1: Pair Button

Below the Accessory Port and adjacent to the Pair button is a small orange LED Pair indicator light. Once this light starts flashing rapidly (strobing about five times per second), release the Pair button.



Figure 10.7.2: Strobing Pairing Light

### Step 2: Reset the Controller

Start with the Controller powered off. Hold the Power and Fly buttons simultaneously until you see the controller-updating display. The Controller then restarts, taking up to five minutes, and then the screen turns off for one minute.

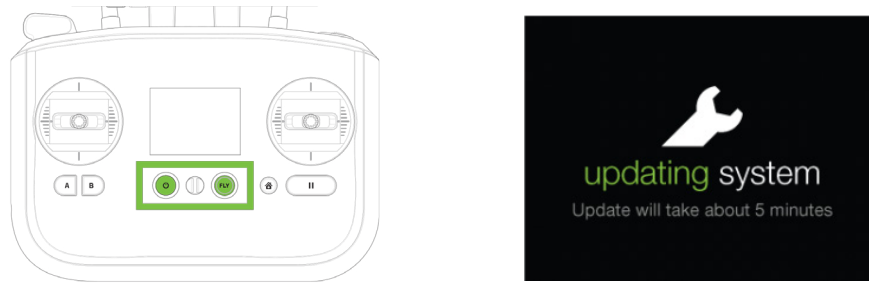

Figure 10.7.3: Controller Reset

When the Controller reset is complete, you will see one of these two completion screens:

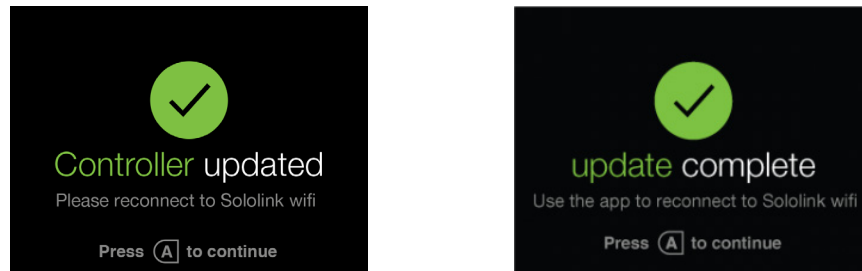

Figure 10.7.4: Controller Update

As **the vehicle reset nears completion, the lights under the arms change between many different colors, followed by a sequence of beeps. When the lights stop changing color, the reset is complete. Upon completion, the lights freeze on their current colors, so they might all be the same or different colors.**

### Step 3: Reboot Solo and the Controller

While rebooting, Solo emits its regular startup tones. The lights underneath Solo’s arms also light up green and change to white in the front and red in the back. **If you do not hear and see these signals, then reboot Solo again. If the lights change colors now, then the vehicle is still resetting. Let Solo finish resetting and then reboot Solo again once the lights stop changing colors.**

After you reboot the controller, it displays the Preflight Update or Waiting for Solo screen.

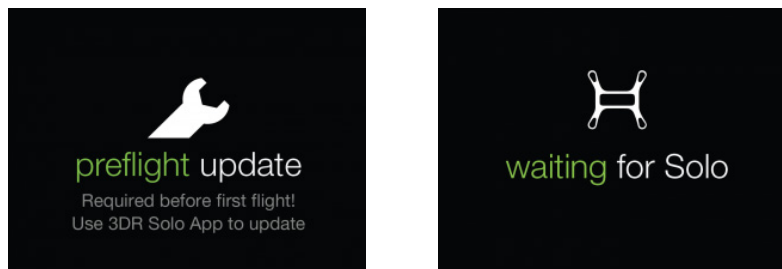

Figure 10.7.2.5: Controller Screen After Reset

### Step 4: Pair Solo and the Controller

For instructions on pairing Solo and the Controller, see section 10.3.

### Step 5: Update your system

For instructions on updating your system, see section 2.6.4. The Factory Reset procedure is now complete.

## 11 Appendix

### 11.1 Specifications

Solo is a quad-rotor aerial vehicle powered by the 3DR Pixhawk 2 autopilot system and APM:Copter flight control software. Solo communicates with the controller and Solo app over the 3DR Link secure Wi-Fi connection.

Autopilot:	3DR Pixhawk 2
Flight code:	ArduPilot Copter
Control:	3DR Solo Controller
Wireless communication:	3DR Link 1.0
Frequency:	2.4 GHz
Height:	10 in. (25 cm)
Motor-to-motor dimension:	18 in. (26 cm)
Propulsion:	880 K <sub>v</sub> motors, two clockwise rotating motors and two counterclockwise rotating motors
Propeller:	10 in. x 4.5 in. (25 cm x 11.4 cm)
Weight with battery:	3.3 lbs. (1.5 kg)
Controller battery life:	3 hours
Extended controller battery life:	6 hours
Controller battery:	Li-ion 2600 mAh 7.2 Vdc (5200 mAh for extended battery)
Power:	Electric (rechargeable lithium polymer battery)
Battery:	Lithium polymer, 5200 mAh, 14.8 Vdc
Battery weight:	1 lb. (.5 kg)
Estimated flight time:	25 minutes*
Maximum altitude:	328 ft. (100 m)
Range:	.5 miles** (.8 km)
Payload capacity:	1.1 lbs. (500 g)
Cruise speed:	5.7 mph (2.5 m/s)
Maximum speed:	55 mph (25.5 m/s)
Maximum climb rate:	11 mph (5.0 m/s)
Maximum descent rate:	5.5 mph (2.5 m/s)
Headwind limitation:	25 mph (11 m/s)
Crosswind limitation:	25 mph (11 m/s)
Camera:	Streaming video compatible with GoPro® HERO 3, 3+ or 4 Full compatibility with GoPro® HERO 4
Solo app compatibility:	iOS 8.0 or later / Android 4.3 or later
Operating temperature:	32° F - 113° F (0° C - 45° C)
Operating relative humidity:	0-85% RH

\*Flight time varies with payload, wind conditions, elevation, temperature, humidity, flying style, and pilot skill. Listed flight time applies to elevations less than 2,000 ft above sea level.

\*\*Range varies with location, antenna orientation, background noise and multi-path.

## 11.2 Warranty

3D Robotics warrants to the original retail purchaser of Solo (the “Product”) that at the time of purchase that this product is free from material defect in materials and workmanship. Should this Product fail during normal consumer usage and conditions due to defective material or workmanship within one year from the date of purchase, or such longer period as is required by applicable law (“Warranty Period”), such defect(s) will be repaired or replaced at 3D Robotics’ option, without charge for parts or labor directly related to the defect(s). The complete terms of the limited warranty applicable to Solo can be found at [3dr.com/terms](http://3dr.com/terms).

This Warranty extends only to consumers who purchase the product from a 3D Robotics authorized reseller and is not transferable or assignable. This Warranty does not apply to: (1) Product subjected to abnormal use or conditions, accident (including without limitation, collision, crash or fire), alteration, or improper repair; (2) damage from exposure to moisture or extreme environmental conditions; (3) damage from use with any accessory, software or other product not expressly authorized by 3D Robotics; (4) damage from external causes such as dirt, sand, battery leakage, blown fuse, or improper usage of any electrical source; (5) commercial use; or (6) use in violation of law or ordinances in effect in the jurisdiction in which the Product is used.

3D Robotics assumes no liability for any accident, injury, death, loss, or other claim related to or resulting from the use of this product. 3D Robotics makes no other warranties for Solo, and makes no warranties whatsoever for service, software, maintenance or support for non-3D Robotics branded products. Such products, service, software, maintenance or support is provided by 3D Robotics “As Is” and any third-party warranties, products, software, services, maintenance or support are provided by the original manufacturer or supplier, not by 3D Robotics.

Software is subject to the separate software license agreement accompanying or made available to you in connection with the software. A portion of the software contains or consists of open-source software, which you may use under the terms and conditions of the specific license under which the open-source software is distributed. You agree that you will be bound by any and all such license agreements, and that your usage of this product indicates your acceptance of those agreements. Title to software remains with the applicable licensor(s). In no event will 3D Robotics be liable to you for damages, including any general, special, incidental or consequential damages arising out of the use or inability to use the software.

THE EXTENT OF 3D ROBOTICS’ LIABILITY UNDER THIS WARRANTY IS LIMITED TO THE REPAIR OR REPLACEMENT PROVIDED ABOVE AND, IN NO EVENT, SHALL ITS LIABILITY EXCEED THE PURCHASE PRICE PAID BY PURCHASER FOR THE PRODUCT.

## 11.3 Regulatory Compliance

### 11.3.1 U.S. - FCC (Federal Communication Commission)

3DR Solo FCC:	2ADYD-S111A
3DR Solo Controller FCC:	2ADYD-AT11A

This device complies with Part 15 of the FCC rules. Operation is subject to the following two conditions: (1) This device may not cause harmful interference, and (2) this device must accept any interference received, including interference that may cause undesired operation.

Changes or modifications not expressly approved by 3D Robotics could void the user’s authority to operate the equipment.

Radiation Exposure Statement:

The Solo system has been tested to ensure compliance with FCC-mandated limits for general population radio frequency (RF) exposure for an uncontrolled environment. These limits ensure that no harmful effects will result from operating Solo according to the standard operating procedures described in this manual.



The body's Specific Absorption Rate (SAR) for the Solo controller is 1.33 watts per kilogram (W/kg) in compliance with the FCC limit of 1.6 W/kg. To reduce exposure to RF energy, hold Solo at least 20 cm away from your body at all times during operation. Do not operate the Solo controller co-located or in conjunction with any other antenna or transmitter.

This device complies with Part 15 of the FCC Rules. Operation is subject to the condition that this device does not cause harmful interference.

### **11.3.2 Declaration of Conformity**

3D Robotics declares that Solo & Solo Controller are in compliance with the essential requirements and other relevant provisions of Directive 1999/5/EC. The declaration of conformity can be obtained from [help@3dr.com](mailto:help@3dr.com).

### **11.3.3 Canada - Industry Canada**

3DR Solo IC: 12768A-S114A  
Model number: S110A

3DR Solo Controller IC: 12768A-AT14A  
Model number: AT10A

This device complies with Industry Canada license-exempt RSS standard(s). Operation is subject to the following two conditions: (1) this device may not cause interference, and (2) this device must accept any interference, including interference that may cause undesired operation of the device.

Le présent appareil est conforme aux CNR d'Industrie Canada applicables aux appareils radio exempts de licence. L'exploitation est autorisée aux deux conditions suivantes : (1) l'appareil ne doit pas produire de brouillage, et (2) l'utilisateur de l'appareil doit accepter tout brouillage radioélectrique subi, même si le brouillage est susceptible d'en compromettre le fonctionnement.

#### **IC Radiation Exposure Statement:**

The Solo system has been tested to ensure compliance with IC-mandated limits for general population radio frequency (RF) exposure for an uncontrolled environment. These limits ensure that no harmful effects will result from operating Solo according to the standard operating procedures described in this manual. To reduce exposure to RF energy, hold Solo at least 20 cm away from your body at all times during operation. Do not operate the Solo controller co-located or in conjunction with any other antenna or transmitter. Changes or modifications not expressly approved by 3D Robotics could void the user's authority to operate the equipment.

**3DR**